

# Bamboo

by Yum Asia



**Induction Heating (IH)**  
**UMAI** Fuzzy Logic Multi Function  
Rice Cooker

Model- YUM IH152, YUM IH15B, YUM IH15  
1.5 litre (1-8 people)

UMAMI  
SMART BRAIN INDUCTION

**GABA  
BROWN**



# INDEX

1.	IMPORTANT SAFEGUARDS Please follow these instructions .....	3
2.	APPLIANCE DESCRIPTION .....	6
2.1	APPLIANCE DESIGN .....	6
2.2	CONTROL PANEL DISPLAY .....	7
3.	APPLIANCE OPERATION .....	8
3.1	BEFORE USE .....	8
3.2	NAVIGATING THE CONTROLS .....	8
3.3	HOW TO USE THE RICE COOKER FUNCTIONS .....	8
3.4	HOW TO USE THE KEEP WARM FUNCTION .....	9
3.5	HOW TO USE THE OTHER COOKING FUNCTIONS .....	10
3.6	CANCELLING PROGRAMMES .....	11
3.7	HOW TO USE THE DELAYED START (PRESET) FUNCTION .....	11
3.8	GABA BROWN AND YUMAMI FUNCTIONS EXPLAINED .....	12
4.	TIPS TO COOKING GREAT TASTING RICE .....	13
4.1	HOW TO COOK PERFECT RICE .....	13
4.2	OUR TIPS FOR RICE COOKING AND GETTING PERFECT RESULTS .....	14
5.	HOW TO USE THE STEAM FUNCTION .....	14
6.	HOW TO BAKE CAKE .....	15
7.	RECIPES .....	15
7.1	CAKES .....	17
8.	COOKING WITH OTHER GRAINS/PULSES IN BAMBOO .....	18
9.	CLEANING AND MAINTENANCE .....	19
10.	REPLACEMENT PARTS .....	20
11.	TROUBLESHOOTING GUIDE .....	20
12.	SPECIFICATIONS AND COOKING TIMES .....	22
13.	CERTIFICATION AND WARRANTY .....	23

Model YUM-IH15/2/B

# Bamboo

Thank you for choosing this Yum Asia Induction Heating (IH) Multi-Function Rice Cooker Model which we named 'Bamboo'. Here at Yum Asia our experience of working with major leading brands of rice cookers and technology has given us the knowledge required to produce this perfect cooker. This means that this product has been designed to the highest standards of quality, functionality and design and more importantly with the passion we have for cooking great rice!

We guarantee that you will be satisfied with your new appliance and this is backed up by our comprehensive warranty service.

For further details, go to [www.yum-asia.com/uk/warranty](http://www.yum-asia.com/uk/warranty) (UK), [www.yum-asia.com/eu/warranty](http://www.yum-asia.com/eu/warranty) (EU) or see the warranty card enclosed. Keep these operating instructions stored away with your warranty card, receipt, and, if possible, the cardboard box and packaging. The latest version of these instructions may be found for viewing or download at [www.yum-asia.com](http://www.yum-asia.com)

If you have any questions about this product, cooking advice or anything else then please contact us at [hello@yum-asia.com](mailto:hello@yum-asia.com) and we will be happy to help.

**ATTENTION! Before using the appliance read these instructions carefully. It contains important information on your safety as well as recommendations on proper appliance use and maintenance.**



**Do not place electronics or objects that are susceptible to magnets in close range of the rice cooker.**

Doing so may cause interference with TV, radio, computer, intercom, transceivers, telephone etc. it may also erase magnetically recorded data (credit/debit cards, train pass, audio tapes etc).



**Individuals with a pacemaker should consult a doctor before using appliances that use Induction Heating. Using this rice cooker may affect a pacemaker**



**Do not place on or near an Induction Cooking Hob.**

Doing so may cause Bamboo to malfunction or break.

Thank you once again and Happy Cooking!









The Yum Asia Team

# 1. IMPORTANT SAFEGUARDS Please follow these instructions

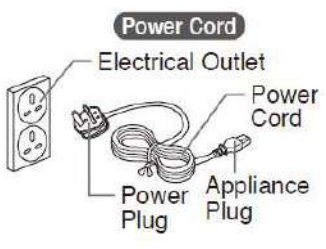

**THESE WARNINGS AND CAUTIONS ARE INTENDED TO PREVENT PROPERTY DAMAGE OR PERSONAL INJURY TO YOU AND OTHERS.**

	<p>Do not modify this rice cooker, only a repair technician may disassemble or repair this unit.</p>		<p>Do not allow children to use the rice cooker unsupervised. Keep it out of reach of very young children. Children are at risk of burns, electric shocks or injury.</p>
	<p>Do not touch the steam vent. Doing so may cause scalding, burns. Take special care with children</p>		<p>Do not open the lid or move the rice cooker during the cooking cycle. Doing so may cause burns – the steam is very hot.</p>
	<p>Do not plug or unplug the power cord with wet hands. Doing so may cause electric shocks or injury</p>		<p>This rice cooker is for cooking rice and other dishes detailed in this manual. Do not use other than for the intended purposes. Always follow the operating instructions and never cook the following: Foods packed in plastic Dishes that use paper towels or other lids to cover the food. Doing so may cause the steam vent to clog.</p>
	<p>Do not immerse the rice cooker in water or splash with water. Doing so may cause a short circuit or electric shocks.</p>		<p>A loosely inserted power plug may cause fire, electric shocks, short circuit, smoke or fire. Use only an electrical outlet that is rated at 15 amperes minimum. If you want to change the power cord, only use one which a similar rated cord (250v, 13A).</p>
	<p>Do not put any metal objects in the air vents. Doing so may cause electric shocks or malfunction resulting in injuries.</p>		<p>If the blades of the plug are dirty, wipe them clean. Debris on the blades of the plug can cause fire</p>
	<p>Insert the power plug completely and securely into the electrical socket.</p>		

	<p>This appliance is intended for household use only. Any use for commercial purposes will void the warranty.</p>		
	<p>Do not use if the power cord or plug is damaged or if the power plug is loosely inserted into the electrical socket. Doing so may cause electric shocks, short circuit or fire. Do not damage the power cord.</p> <div data-bbox="303 593 630 840" style="display: flex; align-items: center;">  <div style="margin-left: 20px;"> <p>Do not bend, twist, bundle or attempt to modify the power cord. Do not place the cord on or near high temperature surfaces or appliances, under heavy items or between objects. A damaged power cord can cause electric shocks or fire.</p> </div> </div>		<p>Unplug the power cord from the electrical socket when not in use</p>
	<p>Do not use any other parts other than those supplied with this rice cooker.</p>		<p>Allow enough space next to walls, other furniture and under shelves for the steam to escape.</p>
	<p>Do not use this rice cooker in a place where it may come in contact with water or other heat sources.</p>		<p>Do not touch hot surfaces during, or immediately after, use. Be careful of steam when opening the lid and be careful not to touch the inner bowl while stirring the rice. Touching hot surfaces with metal parts like the inner lid, inner bowl and heating plate may cause burns.</p>
			<p>Do not place or use this rice cooker on an uneven surface or on a surface that is vulnerable to heat. Doing so may cause fire.</p> <p>Do not use this rice cooker on a slide-out table or shelf with insufficient load capacity. Doing so may damage the table or shelf, causing the rice cooker to fall, resulting in injury or burns. Any shelf or slide-out table must have a load-bearing capacity of at least 18kg.</p>



## IMPORTANT!

**Allow the rice cooker to cool down before cleaning.** Hot parts like the inner lid, inner bowl and heating plate may cause burns.

**Always unplug the rice cooker by holding the power plug, not by pulling the power cord.**

**Insert the end of the power cord firmly into the rice cooker,** otherwise it may cause electric shocks, fire and the rice cooker may not work.

**Do not cover the main body of the rice cooker, especially the steam vent while cooking.**

**Do not damage the inner bowl or inner lid.** A deformed inner bowl or lid will cause uneven cooking results.

**Make sure nothing is stuck to the heating element or the outside of the bowl.** This will cause uneven cooking results.

**Do not cover the fan vents on the side and bottom of the rice cooker.**

**Do not splash water on the rice cooker.** This may cause the breakdown of the unit, fire or electric shock.

**Do not use the rice cooker in direct sunlight.** This may cause discolouration.

**Do not use where the steam from this rice cooker may come into contact with other appliances.** The steam may cause discolouration, malfunction, fire to other appliances.

**Do not use on a surface where the air vents underneath could get blocked** (like on paper, carpet, plastic)

**Do not cook when the inner bowl is empty.** This may cause the breakdown of the unit.

**Stop using immediately if you notice ANY of the following:**

The power plug or cord has become very hot.

The power cord is damaged or the electricity turns on/off when touched

The body of the rice cooker is deformed or unusually hot

Smoke is coming from the rice cooker or there is a burning smell

Any part of the rice cooker is cracked, loose or unstable.

## 2. APPLIANCE DESCRIPTION

Your Bamboo Umai Induction Heating fuzzy logic rice cooker is a modern multi-function cooking appliance using the highest quality manufacturing and our years of experience selling rice cookers.

Saving space in your kitchen, this appliance combines quality functions of speciality rice cooking (white rice, short grain rice, brown rice, Yumami and GABA brown) with porridge, steam, slow cook, crust and cake baking. We designed this rice cooker with additional features that any cook will find useful. An easy to use and state of the art Korean Motouch control function panel with adjustable timings for different functions will make cooking so much easier and produce delicious rice or full meals.

### 2.1 APPLIANCE DESIGN

Meet your Bamboo rice cooker! It is supplied with a rice spatula, a soup ladle, a measuring cup and a steam basket.

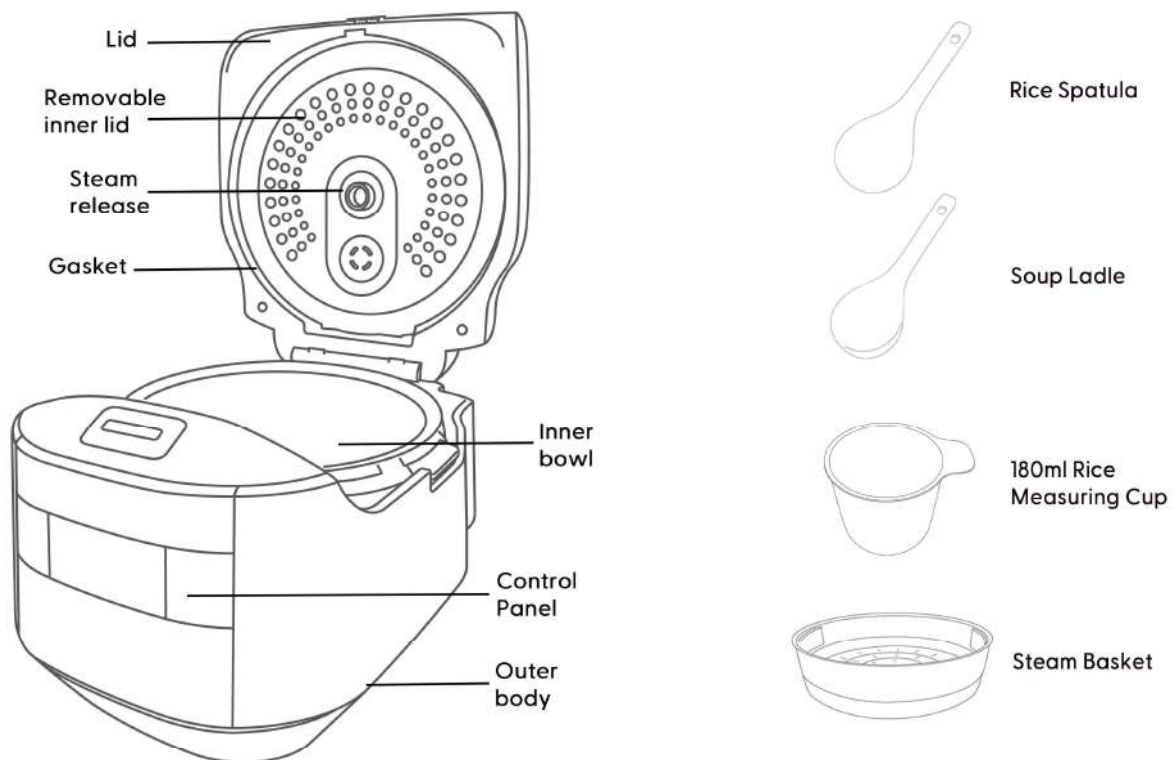

## 2.2 CONTROL PANEL DISPLAY

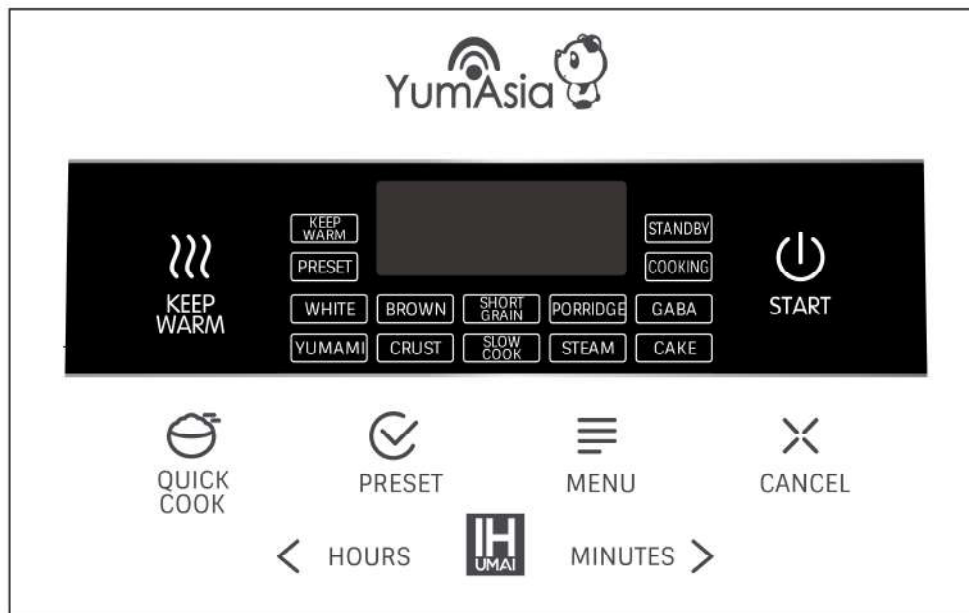

START

Press and hold the 'START' touch button for 2 seconds to activate the cooking program which you have previously selected with the touch button 'MENU'.



CANCEL

Press the 'CANCEL' touch button to cancel the cooking programme. Bamboo will then go to standby mode with the display flashing. This button also doubles as an on/off button by pressing and holding longer than 2 seconds when Bamboo in standby mode.



MENU

Press this touch button to select 1 of 10 automatic cooking programmes, 6 of which are dedicated rice cooking programmes, each successive press of the button moves through the menu and the selected programme flashes on the display.



QUICK COOK

This touch button is for the quick rice cooking programme and is only for white rice, it cannot be used for brown rice



KEEP WARM

If the unit is in stand-by mode (i.e. no programme is in use) pressing and holding the 'KEEP WARM' button for 2 seconds activates KEEP WARM mode and the 'KEEP WARM' button lights up. A count-up clock appears for your reference and the 'KEEP WARM' button stays lit.



PRESET

The 'PRESET' function allows you to set a timer for delayed cooking of up to 24 hours. Beware of setting this for too long in the future if there are perishable foods among the contents of the dish you are cooking.



For adjusting the cooking times for non-rice cooking menu settings and the preset function. Pressing one of these buttons when a programme has been selected allows you to adjust the cooking time. Default cooking times are listed under the specific manual sections for different programmes.



## 3. APPLIANCE OPERATION

### 3.1 BEFORE USE

1. Open the packaging, take out the appliance carefully, and remove all packaging and promotional material.
2. Take out all the accessories and the operating manual.
3. Remove any promotional stickers. Wipe the appliance case with a damp cloth.
4. Wash the bowl and inner lid in warm soapy water with a soft sponge. Dry thoroughly.
5. Cook 0.5 cup of rice (for water, fill measuring cup to ½ with water) and throw it away.

### 3.2 NAVIGATING THE CONTROLS

The display of this unit is touch sensitive and is easy to use with a bright state of the art 'cool ice white' Motouch panel.

**NOTE - the 'START', 'KEEP WARM' and 'CANCEL' buttons are activated by pressing and holding the button for 2 seconds.** The corresponding button then lights up on the control panel and you will hear a fan start.



When no cooking programme is selected, **Bamboo can be turned off** by **pressing and holding the Cancel** button for **2 seconds**.

To **switch Bamboo on**, **press** the **Cancel** button

### 3.3 HOW TO USE THE RICE COOKER FUNCTIONS

**NOTE - the maximum capacity of this appliance (Do Not Exceed!)**

**8 cups (180ml cup) for WHITE rice**

**6 cups (180ml cup) BROWN rice**

Bamboo is designed to cook rice using 7 distinct phases to produce perfect rice every time and to carefully retain nutrients. The phased cooking and adjustments in induction temperature are controlled using Bamboo's IH Umai fuzzy logic processor which also enables more refined cooking of rice in the GABA brown and Yumami settings.

#### OPTIONS FOR COOKING RICE:

1. **'WHITE'** setting is for cooking long grain white rice (for example, basmati, jasmine or Thai fragrant rice)
2. **'QUICK COOK'** setting (for white rice only) for when you want the rice completed a little faster.
3. **'BROWN'** setting is for cooking long or short grain brown rice
4. **'SHORT GRAIN'** setting is for any type of white short grain rice like pearl or sushi rice and Thai sticky rice (see table on next page for water level guide for sticky rice).
5. **'GABA'** setting soaks and 'activates' any type of brown rice to release the gamma-aminobutyric acid, or GABA in the brown rice. Also known as 'hatsuga genmai', it is thought to have many health benefits (see section 3.8, page 12 for further information)
6. **'YUMAMI'** setting is for any type of white rice. This is a specific cooking cycle with different temperatures, it releases sugars contained in the rice and this phased rice cooking is said to make the rice tasted sweeter and 'moreish', hence the name 'Yumami'. (see section 3.8, page 12)

**Approximate cooking times for different types of rice**

Rice Selected	'WHITE'	'QUICK COOK'	'BROWN'	'SHORT GRAIN'	'GABA'	'YUMAMI'
Time taken	35 mins	29 mins	63 mins	39 mins	145 mins	66 mins

There are markings on the inside of the inner bowl to indicate the water levels for white long grain rice, white short grain rice, brown rice and (rice) porridge.

### Cooking **STICKY** or **GLUTINOUS** rice

Sticky or glutinous rice is different to normal short grain rice, it needs more water. If you are cooking sticky/glutinous rice you need to follow the water guidance below and use the short grain setting.

Water levels for 'THAI STICKY/GLUTINOUS' rice							
Cups of rice	1	2	3	4	5	6	7
Water level (short grain marks)	1.5	2.5	3.5	4.5	5.5	6.5	7.5



During the rice cooking cycles, a chasing lines pattern comes on the display to indicate Bamboo is cooking, a **countdown** will appear in the **last 10 minutes**.

### 3.3.1 COOKING RICE IN BAMBOO

1. **Measure** the rice with the measuring cup provided. Make sure the rice is level to the top of the cup – this is a full cup (180ml) measurement.
2. **Clean the rice** (if needed) as directed in '4.1 HOW TO COOK PERFECT RICE'. Place the inner bowl into the appliance, **put the rice into the inner bowl** and **fill to the water line** that corresponds to the amount/type of rice you are cooking.
3. Close the lid and **select** the rice setting you want to cook with.
4. Press and hold '**START**' and the cooking cycle will begin. A chasing lines pattern comes on the display to indicate Bamboo is cooking, a countdown will appear in the last 10 minutes.



**Also see** the 'Speedy Start Guide' on the back of the warranty card for a step-by-step guide on how to cook rice and 'Tips to Cooking Great Tasting Rice' on page 13 for more detailed cooking information and advice.



If you want to cook **1 cup of rice**, there isn't a mark on the inner bowl for this. Use the measuring cup to add the water – 1 measuring cup of water for white rice and 1/2 cups of water for brown rice.

## 3.4 HOW TO USE THE KEEP WARM FUNCTION

Once a cooking cycle has finished, you will hear a series of beeps and Bamboo will automatically switch to 'KEEP WARM'. You can activate 'KEEP WARM' when Bamboo is on stand-by (i.e. when no menu functions have been selected and 'STAND BY' is showing on the display) by pressing and holding the 'KEEP WARM' button for 2 seconds. The button will then light up and a count-up clock will appear on the display for your reference.

The 'Keep Warm' function can be used for 24 hours but you may find that the rice is dry after 15 hours (as rice has to be kept at a safe temperature to eat). You can extend this by periodically adding a little water to the rice and stirring through.

To cancel 'KEEP WARM', press and hold the 'CANCEL' button for 2 seconds. Bamboo will then switch to stand-by mode. If you unplug Bamboo while in keep warm, the next time you plug it in, keep warm will activate, you need to cancel this before you can cook on another setting.

## 3.5 HOW TO USE THE OTHER COOKING FUNCTIONS

### 3.5.1 PORRIDGE

This menu setting can be used for Asian rice porridge or oatmeal porridge. For recipes, see page 15.

The default cooking time for the 'PORRIDGE' setting is 1.5 hours. You can adjust this down to 1 hour or up to 3 hours using the 'Hr' or 'Min' buttons once you have selected the 'PORRIDGE' setting and it is blinking on the display. Once the cooking cycle is complete, Bamboo will make a series of beeps and will automatically switch to 'KEEP WARM'.

### 3.5.2 STEAM

Using the provided steaming basket, you can steam different types of food. The default cooking time for the 'STEAM' setting is 10 minutes. You can adjust this up to 1 hour in 10 minute intervals using the 'Hr' or 'Min' buttons once you have selected the 'STEAM' setting and it is flashing on the display. There will be a countdown on the display – this will only start to countdown when the water has been heated. Using hot water rather than cold water helps speed up the heating process. Fill to the 2-3 water level mark on the inner bowl when using Bamboo as a stand-alone steamer.

See Section 5, page 14 for a guide to steaming

### 3.5.3 SLOW COOK

For cooking stews and other dishes like curries, dhal, or other pulses/grains select the 'SLOW COOK' setting. The default cooking time for the 'SLOW COOK' setting is 3 hours. You can adjust this down to 2 hours or up to 8 hours using the 'Hour' or 'Minute' buttons once you have selected the 'SLOW COOK' setting and it is blinking on the display. When the 'SLOW COOK' cycle starts, Bamboo heats the contents of the inner bowl to a high temperature (97°C), it then switches to a lower temperature (87°C) for the slow cooking. This is the same as the 'auto' setting on a conventional slow cooker.

Once the cooking cycle is complete, Bamboo will make a series of beeps and will automatically switch to 'KEEP WARM'.



Bamboo is a very efficient, sealed unit induction heating rice cooker, the slow cook setting will cook food faster as there is no heat loss. A normal slow cooker recipe with a cook time of 7-8 hours will take 3-4 hours to cook in Bamboo. This is to give a more efficient slow cook.

### 3.5.4 CRUST

For cooking Persian style 'Tahdig' rice with a crust, select the 'CRUST' setting. The default cooking time for the 'CRUST' setting is 1.5 hours. You can adjust this down to 1 hour or up to 2 hours using the 'Hour' or 'Minute' buttons once you have selected the 'CRUST' setting and it is blinking on the display. After a period of time, Bamboo will make a 'beep' and you can open the lid to add any additional ingredients (like butter, oil or spices). You then close the lid to continue cooking.

Once the cooking cycle is complete, Bamboo will make a series of beeps and will automatically switch to 'KEEP WARM'.

### 3.5.5 CAKE

For cooking delicious cakes, select the 'CAKE' setting. The cake setting on your Bamboo makes delicious and moist cakes. Please see section 6 on page 15 for more detailed instructions for cake baking.

The default cooking time for the 'CAKE' setting is 40 mins. This time can be adjusted down to 30 mins and up to 60 mins in 5 mins intervals using the 'Hour' or 'Minute' buttons once you have selected the 'CAKE' setting and it is blinking on the display. Once the cooking cycle is complete, Bamboo will make a series of beeps and will automatically switch to 'KEEP WARM'.

## 3.6 CANCELLING PROGRAMMES

To cancel a programme you have selected, cancel keep warm or, if you want to stop a programme part way through the cooking cycle, you just need to press and hold the 'CANCEL' button for 2 seconds. Bamboo will then switch to standby mode.

## 3.7 HOW TO USE THE DELAYED START (PRESET) FUNCTION

The 'PRESET' function is a useful timer/delayed start feature; this allows you to set the appliance to have your rice or food ready at a specific time. The 'PRESET' function is available for all menu settings.

### To set the timer:

1. Press the 'MENU' touch button to select a cooking programme (for non-rice cooking programmes you can programme the length of cooking time at this point).
2. Then press the 'PRESET' button which will then light up.
3. By pressing the 'Hr' and 'Min' touch buttons you can select the hours in advance when the rice/dish should be ready.
4. Press and hold the 'START' touch button, the cooker will display the hours/minutes in advance you selected, start to count down and the cooking cycle will complete at the time you specified.

If the preset/timer is set to below the minimum stated in the below table, the cooking cycle will start immediately. This is because the default cooking time for each cooking cycle has to be taken into account along with additional assessment time for the fuzzy logic to know what it is cooking.

**Suggested timings for the 'PRESET' function**

Function	RICE	PORRIDGE	YUMAMI	STEAM	SLOW COOK	GABA
Preset timings	70 mins to 24 hrs	70 mins to 24 hrs	70 mins to 24 hrs	1 hr to 24 hrs	130 mins to 24 hrs	150 mins to 24 hrs

**Note** – be aware that perishable foods should not be left for long periods of time when you have set the 'PRESET' function as they may spoil.



The start time of the preset/timer is not exact, it will come on slightly earlier as Bamboo has to assess what exactly is in the inner bowl (rice/oats/water) and volume so it can calculate the cooking time effectively. It deals with this by turning the unit on early so it can 'assess' the contents.

## 3.8 GABA BROWN AND YUMAMI FUNCTIONS EXPLAINED

### 3.8.1 WHAT IS GABA BROWN?

The GABA brown rice (or germinated brown rice) function uses specific timing and temperatures so the brown rice is allowed to germinate. When you select the GABA function on Bamboo it will soak and activate the brown rice for you using its Umai (smart brain) fuzzy logic control, after which it begins to phase in the cooking process. During this process, the inner bowl and its contents are kept at a specific temperature for part of the cooking cycle which enables the brown rice to 'sprout'.

The full cooking time for GABA rice in Bamboo, including the additional activation period, takes around 2 hours 25 minutes to complete. The result of this process alters the flavour and increases the levels of nutrients such as gamma-aminobutyric acid (GABA). GABA brown rice has a softer texture than brown rice and a nuttier flavour.

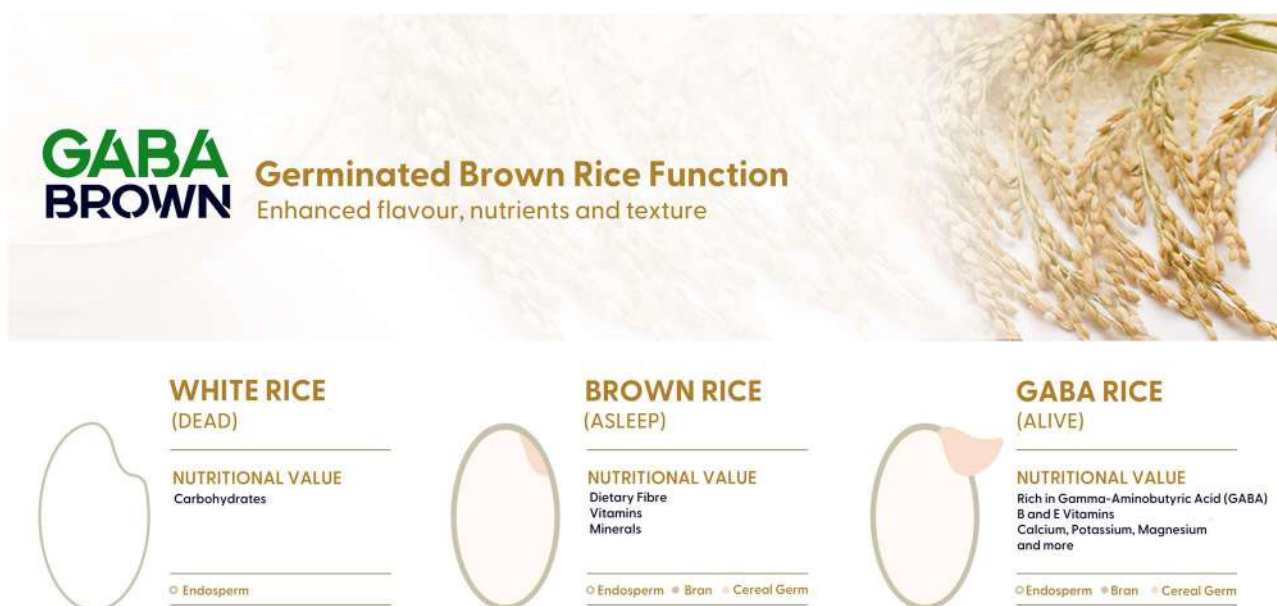

### 3.8.2 WHAT IS YUMAMI?

Yumami or 'extra tasty' rice function on Bamboo enhances the flavour of any type of white rice by using a specially designed cooking cycle.

It does this by using a sequence of soaking and steaming to release the sugars contained in the rice. These sugars are then reabsorbed back into the rice as a different chemical structure and can attach to the surface of the rice. This change in sugar chemistry can then activate Umami receptors of the tongue. The result is more flavourful rice with improved texture and taste.

Usually the rice produced is fluffier, softer and sweeter (depending on the type of white grain used). The full cooking time, including the special soaking and steaming, for the Yumami function on Bamboo is 1 hour, 6 minutes.



## 4. TIPS TO COOKING GREAT TASTING RICE

### 4.1 HOW TO COOK PERFECT RICE

**Measure the rice accurately!** Only use the 180ml measuring cup provided as other cup sizes may be different measurements. Make sure you level the rice off at the top of the cup.

**Rinse the rice!** Do not wash the rice in the inner bowl – sometimes rice can contain small stones that causes scratches to the ceramic coating. Use a separate bowl or sieve. Place the rice into a sieve or a bowl and pour fresh, cold water on top. Stir the rice loosely by hand and drain the water. Do this 2-3 times until the water you are rinsing with runs clear.

For example:  
when cooking 6 cups of WHITE rice

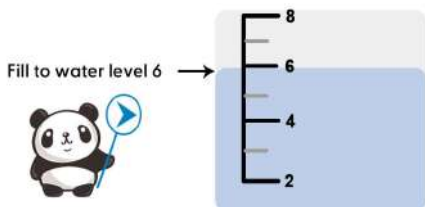

**Be accurate with the water!** The amount of water in the inner bowl prior to cooking greatly affects the texture of the cooked rice. The more water you use, the softer the rice will be when cooked. We recommend after washing the rice, you place it in the inner bowl, then top up with water to the corresponding line on the inner bowl – fill to the underside of the line, this will give you perfect rice. If you prefer it softer, fill to the top of the line; if you prefer it harder, fill to 2-3mm below the line.

**Stir and loosen!** once the appliance has switched to 'KEEP WARM', if possible, stir and loosen the rice straight away with the provided spatula. This helps release excessive moisture and results in nice, perfect fluffy rice.



## 4.2 OUR TIPS FOR RICE COOKING AND GETTING PERFECT RESULTS



Try and choose bags of rice with as few broken grains as possible, as broken grains make rice very soggy and sticky.



It is important to remember that every batch of rice is different - even the rice you regularly buy can sometimes change for the worse quality - each batch of rice absorbs water differently depending on how well it's been processed. The end result can also depend on the age of the rice you use. Newer rice needs less water than older rice but, of course, there is no way of knowing whether the rice you have bought is an older or newer picked grain.



If the rice you cook is too sticky, it's worthwhile trying a batch without rinsing, as some varieties of rice don't need rinsing as they have been processed differently. Unlike pasta, rice isn't consistent because it's a natural product and the first batch cooked from a new purchase of rice can be hit and miss - the rice cooker does mitigate this to an extent, but adjusting the amount of water is a sure way of getting the rice you like.



If the rice you cook is too soft, next time reduce the water you add for cooking by 3-4mm, softer rice means that there was too much water in the inner bowl during cooking. If the rice you cook is too hard, next time add 3-4mm more water, harder rice means that there was too little water in the inner bowl during cooking.



Do not use any kind of quick cook, partially cooked, parboiled rice - look at rice packets carefully to make sure the rice you are buying is suitable. This type of rice is not suited for use in a sealed unit, fuzzy logic rice cooker.

## 5. HOW TO USE THE STEAM FUNCTION

You can use this appliance as a stand alone steamer (use 1.5-2 cups of water) or you can cook rice at the same time as steaming food. If steaming whilst cooking rice, you would use the rice function for the type of rice you are cooking and add the steaming basket to the inner bowl above the rice.

Here is a guide for estimated cooking different types of food on the 'STEAM' function:

INGREDIENTS	AMOUNT	COOKING TIME	TIPS FOR STEAMING
Carrot	200g/1 pc	20 mins	Cut into bite-size pieces
Broccoli	200g	15 mins	Cut into bite-size pieces
Spinach	100g	15 mins	Cut into bite-size pieces
Pumpkin	250g	20 mins	Cut into bite-size pieces
Potato	450g	40 mins	Cut into bite-size pieces
Sweet Potato	300g	35 mins	Cut into bite-size pieces
Corn	200g	30 mins	Cut into bite-size pieces
Chicken	300g/1 fillet	30 mins	Make cuts on side touching steam basket
Fish (white fish & salmon)	150g	25 mins	Slice to less than 2cm and wrap in foil
Prawn/Scallops	15pcs/150g	20 mins	Prawns - Steam without removing shells. Scallops - Remove from shell
Refrigerated Meat Dumpling	200g	15 mins	Leave space between foods
Frozen Meat Dumpling	200g	20 mins	Leave space between foods



**IMPORTANT** - Do not steam food over 3.5cm thick.

If you would like to combine cooking rice with steaming, it is recommended that **3 cups of rice is the maximum capacity you can cook**. Any more than this the steaming basket will push into the lid.



If cooking rice and steaming at the same time, you can open the lid (very carefully, minding the steam that is released from the unit) to add the steaming basket part way through the cooking cycle so the vegetables are not over-cooked.

## 6. HOW TO BAKE CAKE

1. Grease the inner bowl lightly and evenly with butter or oil.
2. Prepare the cake batter. Note – do not use too much baking powder or baking soda as it may cause the cake to rise too high. The maximum weight for all ingredients is 600g, do not exceed this.
3. Place the inner bowl on a hard, flat surface and place the cake mixture into the inner bowl. Shake a little and tap the underside of the bowl gently with the palm of your hand (do this several times) to release any air bubbles in the cake mixture.
4. Place the inner bowl into the appliance and close the lid. Press the 'MENU' button until the 'CAKE' setting blinks on the control panel. You can then choose the length of cooking time – default is 40 minutes but this can be adjusted down to 30 minutes and up to 60 minutes in 5 minute intervals. Press and hold the 'START' button for 2 seconds to start the cooking cycle.
5. Once the cooking cycle is finished, the appliance will switch to 'KEEP WARM', check the cake with a wooden tooth pick or skewer to see if it is cooked. If not, you can cancel the 'KEEP WARM' by pressing and holding the 'CANCEL' button for two seconds and select the 'CAKE' setting as detailed in step 4 to cook for longer.

See page 17 for examples of cake recipes to cook in Bamboo.

## 7. RECIPES

Here are a couple of recipes to start you off with your new rice cooker.

For lots more recipes like flavoured rice (Mexican and coconut rice), risotto, stews, soups and more, please see our foodie blog at [www.greedypanada.co.uk](http://www.greedypanada.co.uk)

### RICE PORRIDGE (CONGEE)

#### Ingredients (4-5 servings)

1 cup of rice

75g chicken thighs, chopped and parboiled

Pinch of salt

Ginger and spring onion (scallion), shredded – to taste

#### Directions

1. Wash rice and place into inner bowl, add water (follow levels on the inner bowl) then place the chicken on top
2. Press the 'MENU' button and select 'PORRIDGE' and press and hold the 'START' button
3. When the rice cooker turns to 'Keep Warm,' add salt if you want it and garnish with ginger and spring onions



## OATMEAL PORRIDGE

### Ingredients (serves 4 – do not exceed quantities)

1 cup steel cut or high quality large rolled oats (we advise you put these in a sieve and shake hard 3-4 times to dislodge any sediment)

3 cups water (measured in the provided measuring cup)

1 cup of milk (or 1 cup of coconut milk or other non-dairy milk – whatever you prefer)

3-4 spoons (or more to your own taste) honey or brown sugar

\* You may need to experiment with the amounts of oats and water, depending on whether you like thick or thin oat porridge!

### Directions

1. Place oats and water in the inner cooking pan.
2. Place the inner cooking pan in the main body of the rice cooker, plug in the unit, select the 'PORRIDGE' setting and adjust the timing to what you prefer (longer cooking time = thicker porridge; less cooking time = thinner porridge) press and hold the 'START' button to start.
3. When the rice cooker turns to keep warm open the lid, stir and add the remaining ingredients. Using the Timer function and soaking the oats overnight will soften the texture of the oats.
4. Add any dried or fresh fruit to the porridge instead of sugar – delicious and healthy on a cold winter's day!!



**Do not use milk to cook the oats**, this will result in a 'boil over' of the contents as milk reacts differently when heated. **Only use water to cook the oats.**

## SUSHI ROLLS

### Ingredients (4-5 servings)

3 cups of rice

For the sushi seasoning (vinegar mix) – 4 tbsp rice vinegar, 1 tbsp sugar, 1.5 tsp salt

Whatever topping you prefer (sashimi, prawns, pickles, natto, salmon roe, eel)

Seaweed, wasabi, soy sauce and pickled red ginger for garnish

### Directions

1. Wash rice and place into inner bowl, add water (follow the water levels on the inner bowl and use the 'SHORT GRAIN' menu option)
2. When the rice cooker turns to 'Keep Warm,' place the rice in a wooden container (wiped with a clean, wet cloth) and pour the vinegar mix over the rice, mixing whilst cooling with a fan
3. Hand rolled sushi is simple and quick, it's just a case of wrapping your favourite ingredient with nori (seaweed)

## RICE PUDDING

### Ingredients (cup measures are for the rice measuring cup 4-6 servings)

2 cups arborio, other short-grain rice or sticky/glutinous rice

½ cup evaporated milk

½ cup coconut milk

1 cup sweetened condensed milk

1 cinnamon stick or pinch of ground cinnamon

1 lemon zest, one large piece of lemon peel

½ teaspoon nutmeg (or less if you prefer)

A sprinkle of ground cinnamon (to garnish)

#### Directions

1. Measure your short grain rice with the measuring cup you got with your rice cooker.
2. Rinse rice in cold water, place rice and water (to the correct line on the inner bowl) into the rice cooker, choose the 'SHORT GRAIN' rice setting.
3. Meanwhile whisk evaporated milk, coconut milk, sweetened condensed milk, cinnamon stick (or ground cinnamon), lemon zest (a large thin slice of zest, not grated) and nutmeg together.
4. When rice is cooked and the rice cooker has switched to keep warm, add the whisked milks into the rice, close the lid. Check about 30 minutes later and see if it is at the consistency you like.
5. Discard the cinnamon stick (if using) and the lemon zest.
6. Place into individual dishes and garnish with ground cinnamon and cream if desired.



\*\* Vegan adaptation - this can also be made without the evaporated milk and condensed milk as a non-dairy alternative.

Use one whole tin of coconut milk and some non-dairy milk to loosen it after stage 5 if necessary.

## 7.1 CAKES

For cakes, you can make things easier by using a ready-made cake mix and adding your favourite ingredients, they still turn out perfectly. If you want to make your own cake batter, be sure to follow the guidance on maximum ingredients.

### BANANA CAKE

#### Ingredients

3 eggs  
110g sugar  
110g melted butter  
200g very ripe bananas (weight without skin)  
160g plain flour  
3/4 tsp baking powder  
3/4 tsp baking soda  
a pinch of salt, less than 1/8 tsp  
butter for greasing the inner bowl

#### Directions

1. Sift the flour, baking powder, baking soda and salt in a big bowl, set aside. Melt the butter and sugar in a non-stick bowl and set aside to cool a while. Mash the bananas with a fork and set aside.
2. Add the beaten eggs to the melted butter and sugar and mix well using a manual whisk or spatula.
3. Add in mashed bananas, mix well using a spatula
4. Finally, fold in sifted flour mixture using a spatula
5. Pour the cake batter into the greased rice cooker bowl. Hit the bottom of the rice cooker bowl with the flat of your hand several times in different parts of the bowl. This will ensure there won't be any large air bubbles in the finished cake.
6. Select the 'CAKE' option and move the time to at least 50 minutes. It may need longer than this, so when the 50 minutes cycle has finished, test the top of the cake by gently pressing it. If it feels firm, it's ready – alternatively insert a toothpick and it shouldn't have any cake mixture stuck to it.
7. Remove the bowl from the rice cooker unit and allow the cake to cool for a while in the bowl. When fully cooled, put your hand inside the rice cooker bowl on top of the cake and tip out onto your hand. The bottom of the cake will have a lovely crust and you can transfer the cake onto a plate.

Serve with whipped cream, ice cream, caramel sauce or just eat by itself for a yummy afternoon treat with a cup of tea

## FUDGE CHEESECAKE

### Ingredients

200g Cream cheese  
50g sugar  
30g sugar – for beating egg whites  
3 pcs eggs – separate egg yolk from white  
30g all purpose flour – sifted  
30ml fresh cream  
4 tsp lemon juice  
vanilla extract to taste  
20g butter melted, butter for greasing inner bowl

### Directions

1. Grease the inside of the inner cooking bowl lightly and evenly with butter
2. Soften cream cheese at room temperature or put in microwave for 30 seconds
3. Place cream cheese in a bowl and mix with wooden spatula until it becomes smooth. Add sugar and blend with wooden spatula.
4. Add yolks one at a time. Blend in sifted all-purpose flour, fresh cream, lemon juice, vanilla extract and melted butter. At this point add a good sprinkling of tiny fudge pieces.
5. In a separate bowl, beat egg whites until foamy. Gradually add sugar until whites begin to hold their shape as a meringue.
6. Gently fold meringue into the cream cheese mixture – do this very, very slowly (this makes sure the cheesecake stays nice and light).
7. Pour the batter into the inner cooking bowl and hit the bottom with the palm of your hand several times to release the air bubbles in the batter. Place the inner cooking bowl into the rice cooker and close the outer lid.
8. Press the MENU button and select the CAKE menu setting. Press the START button and set to the cooking of 60 minutes.
9. When baking completes, allow to cool then place hand on top of cheesecake inside pan and carefully tip out, then slip it onto a ready-made sweet pastry case or onto a biscuit base.

## 8. COOKING WITH OTHER GRAINS/PULSES IN BAMBOO

It's possible to cook other grains and pulses in Bamboo, here is a rough guide for cooking times/settings

### QUINOA

If it's not pre-washed, make sure you rinse it well in a sieve with cold water. Use a 1:1 ratio of quinoa to water (up the water to 1:1.25 if you are using black quinoa) and use the quick cook setting. Once it's finished cooking, fluff up a little and leave on keep warm for 5-10 minutes.

### COUS COUS and GIANT COUS COUS

Use the water levels indicated on the packet and use the quick cook setting as cous cous doesn't require that much cooking anyway.

### MILLET

For each portion you want to cook, measure 1/4 cup of millet into the inner bowl and add 1 cup water for each portion (so if you use 1 cup of millet, add 4 cups water; for 3/4 cup millet add 3 cups water; for 1/2 cup millet add 2 cups water and so on).

Shake a small dash of salt into the water, then close the lid. Plug in the rice cooker and select the 'Porridge' cycle. You can either cook straight away adjusting the timing for how you prefer your millet (longer cooking

will have a thicker consistency; less cooking will have a thinner consistency) or you can use the preset timer for when you will want to eat in the morning. Once cooked you can add whatever flavouring you prefer

### LENTILS and BEANS

The slow cook setting is ideal for cooking lentils or beans – rinse beforehand and follow the water levels indicated on the pack. The porridge setting also works for cooking lentils and beans, if you want to cook at a lower temperature.

### PEARL BARLEY

The slow cook setting is ideal for cooking pearl barley - rinse before cooking and follow the water levels indicated on the pack. Using pearl barley in a large batch of soup will cook within an hour but won't overcook if left for longer.

## 9. CLEANING AND MAINTENANCE

Always remove any remaining pieces of food and clean immediately after use.

Do not use any kind of metal brush, scrubber or harsh chemicals/solvents to clean the dirty parts of the appliance. Do not immerse the appliance in water. Use a damp sponge or soft cloth to clean the outer case. Do not wash rice in the inner bowl, this can cause scratches and the inner bowl coating to deteriorate.

**IMPORTANT** - Never put the inner bowl or inner lid into a dishwasher. The chemicals and washing cycle of a dishwasher are too harsh.

Any damage caused by a dishwasher will not be covered by our warranty.

### INNER LID CARE

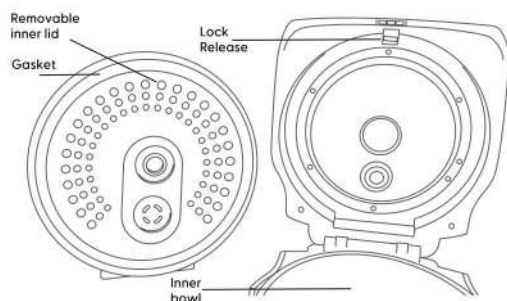

The inner lid of this appliance is removable.

Push the lock release at the top upwards and the lid will come out of its holder. Wash the removable lid after each cooking cycle with a sponge in soapy water.

To put the inner lid back, slide the bottom section behind the two small 'grooves' and push on the top part of the lid until you hear a click.

### IMPORTANT INNER BOWL CARE

Only ever use the plastic accessories provided, you can also use wooden or silicone accessories. Never use metal to stir as this will damage the ceramic coating on the inner bowl.

Cleaning the inner bowl is easy, but if anything remains stuck to the inner bowl, pre-soak with a little washing up liquid before washing.

Do not pour vinegar into the inner bowl as this will damage the ceramic coating.

The outside (underneath) of the inner bowl will discolour and scuff due to the heat being applied to the bowl from the induction element, this is normal. The ceramic coating on the inner bowl may change colour over time. This is completely normal and nothing to worry about.

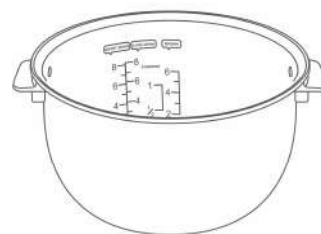

## STEAM CAP CARE

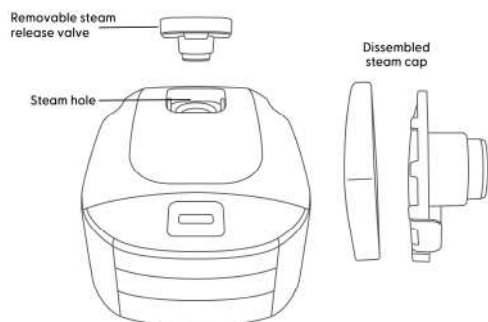

The steam cap on top of the lid is removable – pull upwards to remove.

Wash this on a regular basis.

The removable steam cap can also be full disassembled to ensure full cleaning – ensure this is put together properly before use.

## CONDENSATION COLLECTOR CARE

The condensation collector on the back of the appliance can be removed. Pull on the small handle but be careful not to pull up or down, pull in a straight line otherwise the small handle could break.

Remove and empty the condensation collector. Wash, dry and install it back into place.

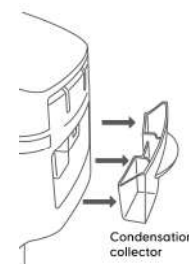

# 10. REPLACEMENT PARTS

If you need spare parts, please contact us via our website [www.yum-asia.com](http://www.yum-asia.com) or e-mail [hello@yum-asia.com](mailto:hello@yum-asia.com). Spare parts available (measuring cups are available to purchase on our website):

Part Name	Part Number
Ceramic coated inner bowl	IB-IH15
Detachable inner lid	ILSS-IH15
Steaming basket	SB-IH15

# 11. TROUBLESHOOTING GUIDE

	PROBLEM	POSSIBLE CAUSE
<b>COOKING RICE</b>	Rice cooks too hard or too soft	<ul style="list-style-type: none"> <li>• Make sure the appliance is on a flat surface, if it is on an uneven surface, the water level becomes inconsistent and it will affect the cooking of the rice.</li> <li>• The texture of rice varies depending on how it's been processed (see section 5.3 for more information)</li> <li>• Using the 'PRESET' function can result in a softer rice texture if the rice has soaked in the water for a length of time.</li> <li>• Using the 'QUICK COOK' setting may result in harder rice</li> <li>• Make sure the inner bowl isn't deformed</li> <li>• Did you loosen the rice after cooking? If not, do this to allow excess water to evaporate</li> </ul>
	Rice is scorched/burnt	<ul style="list-style-type: none"> <li>• Make sure nothing is stuck to the inside of the rice cooker or the bottom of the inner bowl</li> <li>• Rice may not have been washed enough, leaving too much starch on the rice</li> <li>• Make sure the inner bowl isn't deformed</li> </ul>
	Boils over while cooking	<ul style="list-style-type: none"> <li>• Check the 'MENU' setting you have selected and the water level you have filled to</li> </ul>

PROBLEM		POSSIBLE CAUSE	
		<ul style="list-style-type: none"> <li>• Make sure the steam vent cap is on the appliance</li> </ul>	
	Unable to start cooking or buttons won't respond	<ul style="list-style-type: none"> <li>• Make sure the power cord is pushed as far into the appliance as possible</li> <li>• For the 'START', 'KEEP WARM' and 'CANCEL' buttons you need to <b>press and hold for 2 seconds</b></li> </ul>	
	A noise is heard during cooking or keep warm	<ul style="list-style-type: none"> <li>• All Induction Heating rice cookers have a fan fitted, you will hear the fan activate and will turn on/off helping to adjust the cooking temperature of the appliance, it is nothing to worry about</li> </ul>	
	Steam comes out from between the outer lid and main body	<ul style="list-style-type: none"> <li>• Check the outer lid is fitting properly and has not deformed. Is the outer lid gasket dirty? If so, clean the outer lid gasket</li> </ul>	
<b>CAKE BAKING</b>	Cake is not cooked or doesn't rise	<ul style="list-style-type: none"> <li>• The cooking time may have been too short</li> <li>• Beat any egg whites until foamy, otherwise there may not be sufficient rise to the cake</li> <li>• Do not beat egg whites too much – if they separate, they are beaten too much and will cause the cake to collapse</li> <li>• Measure the ingredients accurately – inaccuracy in measuring can cause insufficient baking/rising</li> <li>• Over-mixing the batter when adding the flour may cause insufficient baking or rising</li> <li>• Adding too many additional ingredients can cause the cake to bake unevenly – follow the amount listed in recipes</li> <li>• Bake the cake immediately after preparing the batter - allowing the batter to sit for an extended period of time may deflate the batter and cause the cake to collapse</li> </ul>	
	Cake rises too much	<ul style="list-style-type: none"> <li>• Did you add baking powder or baking soda? Do not add baking powder or baking soda as it may cause the cake to rise too high</li> </ul>	
	Cake is difficult to release from the inner bowl	<ul style="list-style-type: none"> <li>• Make sure you grease the inner bowl well</li> <li>• Leave the cake to cool completely</li> </ul>	
	The cake breaks easily	<ul style="list-style-type: none"> <li>• Freshly baked cake can break easily. Make sure you leave the cake to cool completely before turning out or handling</li> </ul>	
	The cake is scorched/burnt	<ul style="list-style-type: none"> <li>• Make sure the inner bowl isn't deformed</li> <li>• The cooking time may have been too long, make sure you follow the recommended cooking times</li> </ul>	
	<b>NOTE</b> – do not place other cake pans or wax paper into the appliance or inner bowl. Doing so may cause a malfunction or the inner bowl to deform		
<b>STEAMING</b>	Food does not steam	<ul style="list-style-type: none"> <li>• Is there sufficient water for steaming? Make sure there is water to at least the two cup mark on the inner bowl</li> <li>• Is there too much food in the steaming basket? – reduce the amount of food or increase the cooking time</li> <li>• The food may be in too large pieces, reduce the size of food pieces or increase the cooking time</li> </ul>	
	Steamed food is too hard	<ul style="list-style-type: none"> <li>• Vegetables – steaming time was too short. Make sure there is enough water and continue to steam</li> <li>• Fish and meat – steaming time was too long. Reduce the cooking time</li> </ul>	
	Steamed food is cold	<ul style="list-style-type: none"> <li>• Has too much time elapsed from when the cooking cycle ended? Try not to leave on 'KEEP WARM', remove immediately from the appliance and eat</li> </ul>	
<b>KEEP WARM</b>		<ul style="list-style-type: none"> <li>• Do not keep very small amounts of rice on 'KEEP WARM'. Has the 'KEEP WARM' been used for more than 12 hours?</li> <li>• The type of rice and water may have caused the rice to look yellow. Was the spatula left in the inner bowl whilst on 'KEEP WARM'</li> </ul>	

	PROBLEM	POSSIBLE CAUSE
	Rice has a smell, is yellow or there is excessive moisture	<ul style="list-style-type: none"> <li>• Did you loosen rice immediately after it had cooked – if not, loosen</li> <li>• It may be a left over smell from a previous cooking cycle (especially if slow cooking dishes)</li> </ul>
<b>TIMER COOKING</b>	Appliance starts cooking immediately	<ul style="list-style-type: none"> <li>• The minimum default time is 70 minutes, anything less than this will start the cooking cycle immediately</li> </ul>
	Food isn't ready at the set time	<ul style="list-style-type: none"> <li>• Cooking may not complete at the set time if the temperature in the room or the water level is too low</li> <li>• Was there a power cut? This may cause the unit to reset</li> </ul>
<b>GENERAL ERROR ON DISPLAY</b>	'E' error on display, unit beeps and the menu functions won't respond	<ul style="list-style-type: none"> <li>• Was the unit placed on or close to an Induction hob? This will cause a malfunction</li> <li>• Is the inner bowl in place in the unit? If you try and operate the unit without the bowl in place, this is a safety feature to stop use without an inner bowl</li> <li>• Sensors on the unit may have malfunctioned, please contact Yum Asia for further resolution</li> </ul>

## 12. SPECIFICATIONS AND COOKING TIMES

<b>Model name and number</b>	Bamboo, YUM-IH15/2/B
<b>Capacity</b>	1.5 litre (1 to 8 cups) rice cooker or 4 litre slow cooker
<b>Rating</b>	AC 220-240V, 50-60Hz
<b>Electric consumption</b>	1110W
<b>Average power consumption on 'KEEP WARM'</b>	45W
<b>Cooking system</b>	Induction Heating
<b>Country of manufacture</b>	China
<b>Length of power cord</b>	1m
<b>External dimensions (approximate)</b>	37cm (length) x 27cm (width) x 24cm (height)
<b>Weight (approximate)</b>	5.5kg

<b>COOKING CAPACITY (cups or litres)</b>	FEATURE	CAPACITY	APPROXIMATE COOKING TIMES
	<b>Quick cook rice</b>	1-8 cups/1.4l	29 minutes
	<b>White Long grain rice</b>	1-8 cups/1.4l	35 minutes
	<b>White Short grain rice</b>	1-8 cups/1.4l	39 minutes
	<b>Yumami (white) rice</b>	1-8 cups/1.4l	66 minutes (1 hr, 6 minutes)
	<b>Brown rice</b>	1-6 cups/0.9l	63 minutes (1 hr, 3 minutes)
	<b>GABA (brown) rice</b>	1-6 cups/0.9l	145 minutes (2 hrs, 25 mins)
	<b>Porridge (oat or rice)</b>	1 cup/0.18l	1 hour, can be adjusted to 3 hours maximum
	<b>Steam</b>	Water to 2 cup rice mark	5 minutes, can be adjusted up to 1 hour maximum in 5 mins intervals
	<b>Slow Cook</b>	1.5 litres	2 hours, can be adjusted to 8 hours maximum
<b>Crust</b>	1-8 cups/1.4l	1.5 hours, can be adjusted down to 1 hour or up to 2 hours maximum	
<b>Cake</b>	600g of all ingredients	50 mins, can be adjusted down to 30 mins and up to 1.5 hours maximum in 5 mins intervals	



## 13. CERTIFICATION AND WARRANTY

Included with this appliance is our comprehensive warranty (please see warranty card included). For more details of our warranty go to [www.yum-asia.com/uk/warranty](http://www.yum-asia.com/uk/warranty) (UK) and [www.yum-asia.com/eu/warranty](http://www.yum-asia.com/eu/warranty) (EU)

This Yum Asia rice cooker and multi-function cooker is designed for DOMESTIC USE ONLY. It's use in a commercial setting will invalidate this warranty.

If you encounter a problem with your appliance, please first look at the 'Troubleshooting' guide on page 20 of the manual to see if your problem is listed there. If you continue to have a problem, please e-mail [hello@yum-asia.com](mailto:hello@yum-asia.com) with your order details, a description and photos of the problem.



Your appliance is designed and manufactured with the highest quality materials and components which can be recycled and re-used.

This symbol means that electrical and electronic equipment, when at their end of life, should be disposed of separately from household waste. Please dispose of this appliance at your local community waste/recycling centre.



This appliance is compliant with the Restriction Of Hazardous Substances (RoHS) directive.



This appliance is certified for compliance for distribution and use in the EEA



This appliance is certified for compliance for distribution and use in the UK

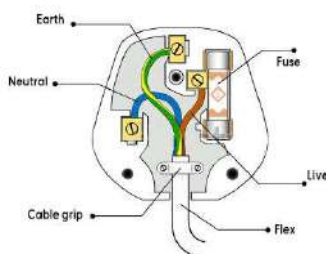

**IMPORTANT!** - The wires in this mains power cord are coloured as:

Green and yellow = Earth Brown or Red = Live Blue or Black = Neutral  
Connect the Earth wire (green and yellow) to the terminal in the plug which is marked with the letter E or by the earth symbol or coloured green and yellow. Connect the Neutral wire to the terminal which is marked with the letter N or coloured black. Connect the Live wire to the terminal which is marked with the letter L or coloured red. This appliance must be protected by a 13A fuse if a 13A (BS1363) plug is used.

**YUM ASIA**  
UK – USA – EU

[www.yum-asia.com](http://www.yum-asia.com)  
© Yum Asia

### UK OFFICE

Yum Asia  
Horizon International Cargo Limited  
Unit 14, 5 Mills Road  
Aylesford  
Kent ME20 7NA

### EU OFFICE

Yum Asia  
Horizon International Cargo c/o Mondial Logistics  
Vredeweg 46  
1505 HH Zaandam  
The Netherlands





# JOUBU

Ceramic Bowl



[www.yum-asia.com](http://www.yum-asia.com)  
UK - USA - EU