

Tsuki

by Yum Asia



Advanced Fuzzy Logic Mini Rice Cooker

Model YUM-TS04W, YUM-TS04T
0.45 litre (1-2 people)

SHINSEI
Ceramic Bowl

ADVANCED
Fuzzy Logic 

YUMAMI

Small
FOOTPRINT 

INDEX

1.	IMPORTANT SAFEGUARDS Please follow these instructions.....	3
2.	APPLIANCE DESCRIPTION.....	6
2.1	APPLIANCE DESIGN.....	6
2.2	CONTROL PANEL DISPLAY.....	7
3.	APPLIANCE OPERATION.....	7
3.1	BEFORE USE.....	7
3.2	NAVIGATING THE CONTROLS.....	7
3.3	HOW TO USE THE RICE COOKER FUNCTIONS.....	8
3.4	HOW TO USE THE KEEP WARM FUNCTION.....	9
3.5	HOW TO USE THE OTHER COOKING FUNCTIONS.....	9
3.6	CANCELLING PROGRAMMES.....	10
3.7	HOW TO USE THE DELAYED START (PRESET) FUNCTION.....	10
3.8	YUMAMI FUNCTION EXPLAINED.....	11
4.	TIPS TO COOKING GREAT TASTING RICE.....	12
4.1	HOW TO COOK PERFECT RICE.....	12
4.2	OUR TIPS FOR RICE COOKING AND GETTING PERFECT RESULTS.....	12
5.	GUIDE TO CLAYPOT RICE.....	13
6.	RECIPES.....	14
7.	COOKING WITH OTHER GRAINS/PULSES IN TSUKI.....	16
8.	CLEANING AND MAINTENANCE.....	16
9.	REPLACEMENT PARTS.....	17
10.	TROUBLESHOOTING GUIDE.....	18
11.	SPECIFICATIONS AND COOKING TIMES.....	19
12.	CERTIFICATION AND WARRANTY.....	19

Model YUM-TS04T/W

Tsuki

Thank you for choosing this Yum Asia mini Multi-Function Rice Cooker Model which we named 'Tsuki'. Here at Yum Asia our experience of working with major leading brands of rice cookers and technology has given us the knowledge required to produce this perfect cooker. This means that this product has been designed to the highest standards of quality, functionality and design and more importantly with the passion we have for cooking great rice!

We guarantee that you will be satisfied with your new appliance and this is backed up by our comprehensive warranty service.

For further details, go to www.yum-asia.com/uk/warranty (UK), www.yum-asia.com/eu/warranty (EU) or see the warranty card enclosed. Keep these operating instructions stored away with your warranty card, receipt, and, if possible, the cardboard box and packaging. The latest version of these instructions may be found for viewing or download at www.yum-asia.com

If you have any questions about this product, cooking advice or anything else then please contact us at hello@yum-asia.com and we will be happy to help.

ATTENTION! Before using the appliance read these instructions carefully. It contains important information on your safety as well as recommendations on proper appliance use and maintenance.



Check the ceramic inner bowl carefully for cracks

The inner bowl is made from ceramic clay material. Any crack in the surface may cause Tsuki to malfunction or break. In contrast to other rice cooker inner bowls, Tsuki's inner bowl is made from a natural material and made by hand, the coating layer of the bowl may look uneven.



Wash the bowl very carefully

Take care not to bang the bowl when washing. Do not use any abrasive chemicals/washing liquids or brushes/scrubbing pads on the bowl. Do not wash the outside of the bowl or immerse in water.



Cooking in a natural ceramic inner bowl

Due to the heat retention properties of the inner bowl, occasionally you may find a very slight crust on the very bottom of the cooked rice. This is nothing to worry about and once you mix it with the rest of the rice, it will disappear.

Thank you once again and Happy Cooking!









The Yum Asia Team

1. IMPORTANT SAFEGUARDS Please follow these instructions



THESE WARNINGS AND CAUTIONS ARE INTENDED TO PREVENT PROPERTY DAMAGE OR PERSONAL INJURY TO YOU AND OTHERS.

	<p>Do not modify this rice cooker, only a repair technician may disassemble or repair this unit.</p>		<p>This device may be used by children aged 8 years and older, and by persons with reduced physical, sensory or mental capabilities or lacking experience and knowledge if they have received supervision or instructions concerning use of the appliance in a safe manner and understand the hazards involved.</p> <p>Cleaning and maintenance by the user is not to be carried out by unsupervised children.</p> <p>Children must not play with the appliance.</p>
	<p>Do not touch the steam vent. Doing so may cause scalding, burns. Take special care with children</p>		<p>Do not open the lid or move the rice cooker during the cooking cycle. Doing so may cause burns – the steam is very hot.</p>
	<p>Do not plug or unplug the power cord with wet hands. Doing so may cause electric shocks or injury</p>		<p>This rice cooker is for cooking rice and other dishes detailed in this manual. Do not use other than for the intended purposes. Always follow the operating instructions and never cook the following:</p> <ul style="list-style-type: none"> Foods packed in plastic Dishes that use paper towels or other lids to cover the food. <p>Doing so may cause the steam vent to clog.</p>
	<p>Do not immerse the rice cooker in water or splash with water. Doing so may cause a short circuit or electric shocks.</p>		<p>A loosely inserted power plug may cause fire, electric shocks, short circuit, smoke or fire. Use only an electrical outlet that is rated at 15 amperes minimum. If you want to change the power cord, only use one which a similar rated cord (250v, 13A).</p> <p>If the blades of the plug are dirty, wipe them clean. Debris on the blades of the plug can cause fire</p>
	<p>Do not put any metal objects in the air vents. Doing so may cause electric shocks or malfunction resulting in injuries.</p>		
	<p>Insert the power plug completely and securely into the electrical socket.</p>		

	<p>This appliance is intended for household use only. Any use for commercial purposes will void the warranty.</p>		
	<p>Do not use if the power cord or plug is damaged or if the power plug is loosely inserted into the electrical socket. Doing so may cause electric shocks, short circuit or fire. Do not damage the power cord.</p> <div data-bbox="349 562 649 777" data-label="Diagram"> </div> <p>Do not bend, twist, bundle or attempt to modify the power cord. Do not place the cord on or near high temperature surfaces or appliances, under heavy items or between objects. A damaged power cord can cause electric shocks or fire.</p>		<p>Unplug the power cord from the electrical socket when not in use</p>
	<p>Do not use any other parts other than those supplied with this rice cooker.</p>		<p>Allow enough space next to walls, other furniture and under shelves for the steam to escape.</p>
	<p>Do not use this rice cooker in a place where it may come in contact with water or other heat sources.</p>		<p>Do not touch hot surfaces during, or immediately after, use. Be careful of steam when opening the lid and be careful not to touch the inner bowl while stirring the rice. Touching hot surfaces with metal parts like the inner lid, inner bowl and heating plate may cause burns.</p>
			<p>Do not place or use this rice cooker on an uneven surface or on a surface that is vulnerable to heat. Doing so may cause fire.</p> <p>Do not use this rice cooker on a slide-out table or shelf with insufficient load capacity. Doing so may damage the table or shelf, causing the rice cooker to fall, resulting in injury or burns. Any shelf or slide-out table must have a load-bearing capacity of at least 18kg.</p>



IMPORTANT!

Allow the rice cooker to cool down before cleaning. Hot parts like the inner lid, inner bowl and heating plate may cause burns.

Always unplug the rice cooker by holding the power plug, not by pulling the power cord.

Insert the end of the power cord firmly into the rice cooker, otherwise it may cause electric shocks, fire and the rice cooker may not work.

Do not cover the main body of the rice cooker, especially the steam vent while cooking.

Do not damage the inner bowl or inner lid. A deformed inner bowl or lid will cause uneven cooking results.

Make sure nothing is stuck to the heating element or the outside of the bowl. This will cause uneven cooking results.

Do not cover the fan vents on the side and bottom of the rice cooker.

Do not splash water on the rice cooker. This may cause the breakdown of the unit, fire or electric shock.

Do not use the rice cooker in direct sunlight. This may cause discolouration.

Do not use where the steam from this rice cooker may come into contact with other appliances. The steam may cause discolouration, malfunction, fire to other appliances.

Do not use on a surface where the air vents underneath could get blocked (like on paper, carpet, plastic)

Do not cook when the inner bowl is empty. This may cause the breakdown of the unit.

Stop using immediately if you notice ANY of the following:

The power plug or cord has become very hot.

The power cord is damaged or the electricity turns on/off when touched

The body of the rice cooker is deformed or unusually hot

Smoke is coming from the rice cooker or there is a burning smell

Any part of the rice cooker is cracked, loose or unstable.

2. APPLIANCE DESCRIPTION

Your Tsuki mini fuzzy logic rice cooker is a modern multi-function cooking appliance using the highest quality manufacturing and our years of experience selling rice cookers.

Saving space in your kitchen, this appliance combines quality functions of speciality rice cooking (white rice, short grain rice, brown rice, Yumami and claypot) with porridge and slow cook. We designed this rice cooker with additional features that any cook will find useful. An easy-to-use Smart Logic button control function panel with adjustable timings for different functions will make cooking so much easier and produce delicious rice or full meals.

2.1 APPLIANCE DESIGN

Meet your Tsuki rice cooker! It is supplied with a rice spatula, a soup ladle and a measuring cup.

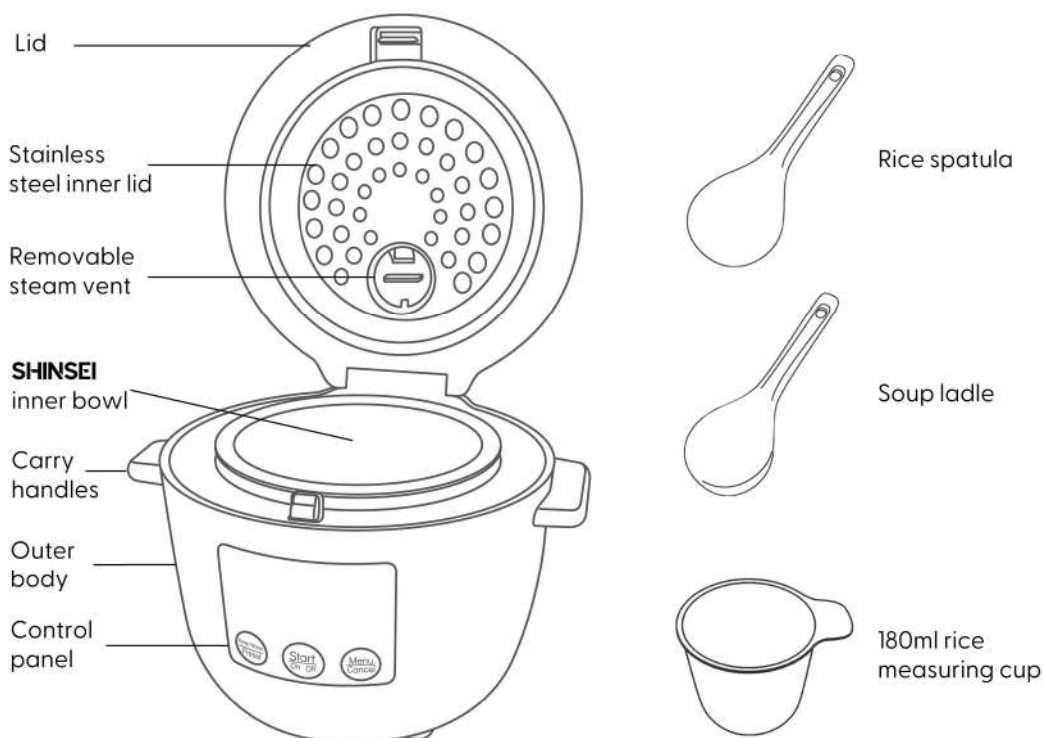

2.2 CONTROL PANEL DISPLAY

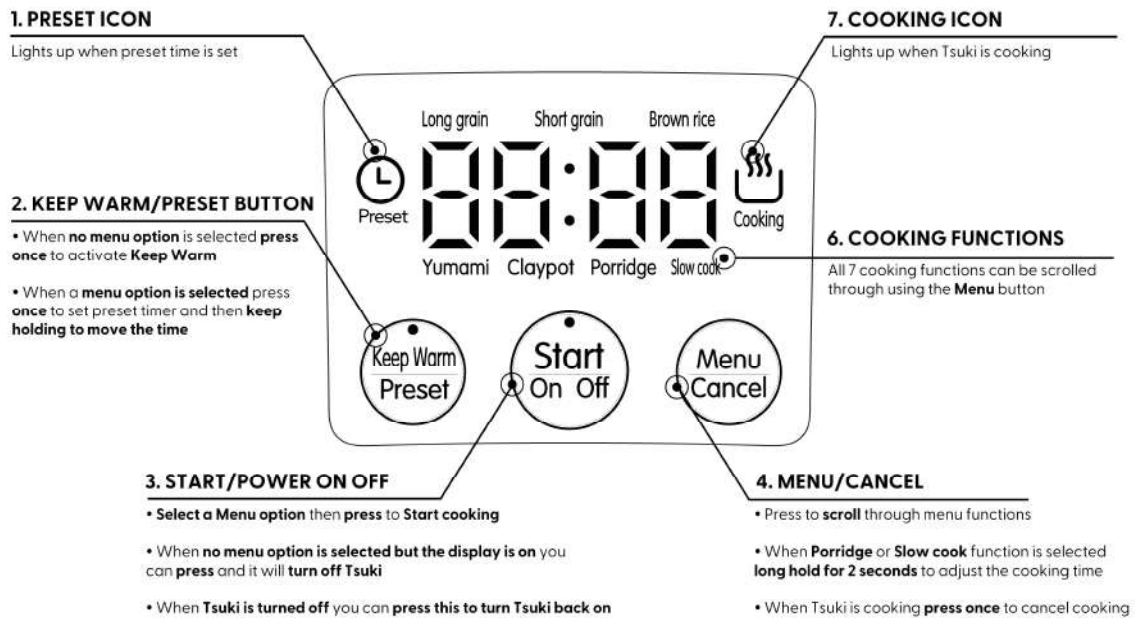

3. APPLIANCE OPERATION

3.1 BEFORE USE

1. Open the packaging, take out the appliance carefully, and remove all packaging and promotional material.
2. Take out all the accessories and the operating manual.
3. Remove any promotional stickers. Wipe the appliance case with a damp cloth.
4. Wash the bowl and inner lid in warm soapy water with a soft sponge. Dry thoroughly.
5. Cook $\frac{1}{2}$ cup of rice (for water, fill measuring cup to $\frac{1}{2}$ with water) and throw it away.

3.2 NAVIGATING THE CONTROLS

The display of this unit is touch sensitive and is easy to use with a Smart Logic button control function panel.

NOTE - the 'Start/On Off', 'Keep Warm/Presets' and 'Menu/Cancel' buttons are all multi-function, multi-purpose buttons. Depending on what is selected and the length of hold on the button means the function of the button will change.



When no cooking programme is selected, **Tsuki can be turned off** by **pressing** the **Start/On Off** button. To **switch Tsuki on**, **press** the **Start/On Off** button again.

3.3 HOW TO USE THE RICE COOKER FUNCTIONS

NOTE - the maximum capacity of this appliance (Do Not Exceed!)

2.5 cups (180ml cup) for WHITE rice

1.5 cups (180ml cup) BROWN rice

Tsuki is designed to cook rice using 7 distinct phases to produce perfect rice every time and to carefully retain nutrients. These phases are Preheat, Absorb water, Heating, Boiling, Braising, Absorb water and then finally Keep Warm (in this order). This phased cooking and adjustments in temperature are controlled using Tsuki's fuzzy logic processor and are programmed to mimic the traditional 'kamado' style of rice cooking.

OPTIONS FOR COOKING RICE:

1. **'Long Grain'** setting is for cooking long grain white rice (for example, basmati, jasmine or Thai fragrant rice)
2. **'Short Grain'** setting is for any type of white short grain rice like pearl or sushi rice and Thai sticky rice (see table on next page for water level guide for sticky rice).
3. **'Brown'** setting is for cooking long or short grain brown rice
4. **'Yumami'** setting is for any type of white rice. This is a specific cooking cycle with different temperatures, it releases sugars contained in the rice and this phased rice cooking is said to make the rice tasted sweeter and 'moreish', hence the name 'Yumami'. (see section 3.8, page 11). Best used for 2 or 2.5 cups, some crusting may occur when cooking 1 cup.
5. **'Claypot'** setting is for cooking any type of white rice in a traditional 'claypot style' with meat, vegetables and a slight crust on the bottom

Approximate cooking times for different types of rice

Rice Selected	'Long grain'	'Short Grain'	'Brown'	'YUMAMI'	'Claypot'
Time taken	29-39 mins	28-36 mins	49-50 mins	60-70 mins	75 mins

Note – these times are approximate and can vary depending on how much rice is being cooked and how the rice absorbs water

There are markings on the inside of the inner bowl to indicate the water levels for white long grain rice, white short grain rice, brown rice and (rice) porridge.

Cooking STICKY or GLUTINOUS rice

Sticky or glutinous rice is different to normal short grain rice, it needs more water. If you are cooking sticky/glutinous rice you need to follow the water guidance below and use the short grain setting. Depending on the sticky/glutinous rice type, it may not need extra water, in this case use the water levels for short grain rice.

Water levels for 'THAI STICKY/GLUTINOUS' rice

Cups of rice	1	2
Water level (short grain marks)	1.5	2.5



When a cooking cycle is first selected, an estimated cooking time will display. When you press 'Start', a chasing lines pattern comes on the display to indicate Tsuki is cooking, then a **beep sounds** and a **countdown** will appear in the **last 10 minutes**.

3.3.1 COOKING RICE IN TSUKI

1. **Measure** the rice with the measuring cup provided. Make sure the rice is level to the top of the cup – this is a full cup (180ml) measurement.
2. **Clean the rice** (if needed) as directed in '4.1 HOW TO COOK PERFECT RICE'. Place the inner bowl into the appliance, **put the rice into the inner bowl** and **fill to the water line** that corresponds to the amount/type of rice you are cooking.
3. Close the lid and **select** the rice setting you want to cook with.
4. Press '**Start**' and the cooking cycle will begin. A chasing lines pattern comes on the display to indicate Tsuki is cooking, a beep sounds and a countdown will appear in the last 10 minutes.



Also see the 'Speedy Start Guide' on the back of the warranty card for a step-by-step guide on how to cook rice and 'Tips to Cooking Great Tasting Rice' on page 12 for more detailed cooking information and advice.



If you want to cook $\frac{1}{2}$ cup of rice, there isn't a mark on the inner bowl for this. Use the measuring cup to add the water – $\frac{1}{2}$ a measuring cup of water for white rice and $\frac{3}{4}$ cup of water for brown rice.

3.4 HOW TO USE THE KEEP WARM FUNCTION

Once a cooking cycle has finished, you will hear a series of beeps and Tsuki will automatically switch to 'Keep Warm'. You can activate 'Keep Warm' when Tsuki is on stand-by (i.e. when no menu functions have been selected and 4 horizontal lines are on the display) by pressing the 'Keep Warm' button. The button will then light up and a count-up clock will appear on the display for your reference.

The 'Keep Warm' function can be used for 24 hours but you may find that the rice is dry after 15 hours (as rice has to be kept at a safe temperature to eat). You can extend this by periodically adding a little water to the rice and stirring through.

To Cancel 'Keep Warm', press the 'Cancel' button. Tsuki will then switch to stand-by mode. If you unplug Tsuki while in Keep Warm, the next time you plug it in, Keep Warm will activate, you need to Cancel this before you can cook on another setting.

3.5 HOW TO USE THE OTHER COOKING FUNCTIONS

3.5.1 PORRIDGE

This menu setting can be used for Asian rice porridge or oatmeal porridge. For recipes, see page 15.

The default cooking time for the 'Porridge' setting is 1 hour. You can adjust this up to 1.5 hours. When the Porridge setting has been selected using the 'Menu/Cancel' button, press and hold the 'Menu/Cancel' button to adjust the length of cooking time. You can press to move in 5 minutes increments or long hold to move through the 5 minutes increments faster.

Once the cooking cycle is complete, Tsuki will make a series of beeps and will automatically switch to 'Keep Warm'.

3.5.2 CLAYPOT

Due to the unique properties of Tsuki's handmade (clay) natural ceramic bowl, traditional style 'claypot rice' can be cooked in Tsuki. This is a traditional dish that has many versions spanning from Dominican Republic to Spain to Korea. Usually cooked with a stock rather than water, along with mushrooms, Chinese sausage or other meat and green, leafy vegetables, the Claypot setting produces a one pot meal with a delicious to-be-fought-over crispy bottom.

See Section 5, page 13 for a guide to Claypot rice

3.5.3 SLOW COOK

For cooking stews and other dishes like curries, dhal, or other pulses/grains select the 'Slow Cook' setting. The default cooking time for the 'Slow Cook' setting is 2 hours and can be adjusted up to 6 hours. When the 'Slow Cook' setting has been selected using the 'Menu/Cancel' button, press and hold the 'Menu/Cancel' button to adjust the length of cooking time. You can press to move in 30 minutes increments or long hold to move through the 30 minutes increments faster.

When the 'Slow Cook' cycle Starts, Tsuki heats the contents of the inner bowl to a high temperature (97°C), it then switches to a lower temperature (87°C) for the slow cooking. This is the same as the 'auto' setting on a conventional slow cooker.

Once the cooking cycle is complete, Tsuki will make a series of beeps and will automatically switch to 'Keep Warm'.



Tsuki is a very efficient, sealed unit rice cooker, the slow cook setting will cook food faster as there is no heat loss. A normal slow cooker recipe with a cook time of 7-8 hours will take 3-4 hours to cook in Tsuki. This is to give a more efficient slow cook.

3.6 CANCELLING PROGRAMMES

To cancel a programme you have selected, cancel Keep Warm or, if you want to stop a programme part way through the cooking cycle, you just need to press the 'Cancel' button. Tsuki will then switch to standby mode.

3.7 HOW TO USE THE DELAYED START (PRESET) FUNCTION

The 'Preset' function is a useful timer/delayed Start feature; this allows you to set the appliance to have your rice or food ready at a specific time. The 'Preset' function is available for all menu settings.

To set the timer:

1. Press the 'Menu/Cancel' button to select a cooking programme (for non-rice cooking programmes you can programme the length of cooking time at this point).
2. Then press the 'Preset' button, which will then light up and 'Preset' appears on the display. By long holding the 'Preset' button you can change the length of time for the preset/timer for when you want the rice/dish should be ready. You can press to move in 15 minutes increments or long hold to move through the 15 minutes increments faster.
3. Press the 'Start' button, the cooker will display the hours/minutes in advance you selected, it will then start to count down and the cooking cycle will complete at the time you specified.

If the Preset/timer is set to below the minimum stated in the below table, the cooking cycle will Start immediately. This is because the default cooking time for each cooking cycle has to be taken into account along with additional assessment time for the fuzzy logic to know what it is cooking.

Suggested timings for the 'Preset' function

Function	Rice	Porridge	Yumami	Claypot	Slow Cook
Preset timings	1.5 hrs to 24 hrs	2.5 hrs to 24 hrs	2.5 hrs to 24 hrs	2.5 hrs to 24 hrs	3 hrs to 24 hrs

Note – be aware that perishable foods should not be left for long periods of time when you have set the 'Preset' function as they may spoil.



The Start time of the Preset/timer is not exact, it will come on slightly earlier as Tsuki has to assess what exactly is in the inner bowl (rice/oats/water) and volume so it can calculate the cooking time effectively. It deals with this by turning the unit on early so it can 'assess' the contents.

3.8 YUMAMI FUNCTION EXPLAINED

Yumami or 'extra tasty' rice function on Tsuki enhances the flavour of any type of white rice by using a specially designed cooking cycle. It does this by using a sequence of soaking and steaming to release the sugars contained in the rice. These sugars are then reabsorbed back into the rice as a different chemical structure and can attach to the surface of the rice. This change in sugar chemistry can then activate Umami receptors of the tongue. The result is more flavourful rice with improved texture and taste.

Usually the rice produced is fluffier, softer and sweeter (depending on the type of white grain used). The full cooking time, including the special soaking and steaming, for the Yumami function on Tsuki is between 1 hour and 1 hour, 10 minutes.

NOTE – due to the unique properties of Tsuki's natural, handmade ceramic inner bowl, cooking only 1 cup of rice may result in some slight crusting. The Yumami function therefore works better with 2 or 2.5 cups of rice.



4. TIPS TO COOKING GREAT TASTING RICE

4.1 HOW TO COOK PERFECT RICE

Measure the rice accurately! Only use the 180ml measuring cup provided as other cup sizes may be different measurements. Make sure you level the rice off at the top of the cup.

Rinse the rice! Do not wash the rice in the inner bowl – sometimes rice can contain small stones that causes scratches to the ceramic coating. Use a separate bowl or sieve. Place the rice into a sieve or a bowl and pour fresh, cold water on top. Stir the rice loosely by hand and drain the water. Do this 2-3 times until the water you are rinsing with runs clear.

For example:
when cooking 2 cups
of WHITE rice

Fill to water level 2

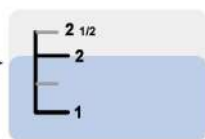

Be accurate with the water! The amount of water in the inner bowl prior to cooking greatly affects the texture of the cooked rice. The more water you use, the softer the rice will be when cooked. We recommend after washing the rice, you place it in the inner bowl, then top up with water to the corresponding line on the inner bowl – fill to the underside of the line, this will give you perfect rice. If you prefer it softer, fill to the top of the line; if you prefer it harder, fill to 2-3mm below the line.

Stir and loosen! once the appliance has switched to 'Keep Warm', if possible, stir and loosen the rice straight away with the provided spatula. This helps release excessive moisture and results in nice, perfect fluffy rice.

4.2 OUR TIPS FOR RICE COOKING AND GETTING PERFECT RESULTS



Try and choose bags of rice with as few broken grains as possible, as broken grains make rice very soggy and sticky.



It is important to remember that every batch of rice is different - even the rice you regularly buy can sometimes change for the worse quality - each batch of rice absorbs water differently depending on how well it's been processed. The end result can also depend on the age of the rice you use. Newer rice needs less water than older rice but, of course, there is no way of knowing whether the rice you have bought is an older or newer picked grain.



If the rice you cook is too sticky, it's worthwhile trying a batch without rinsing, as some varieties of rice don't need rinsing as they have been processed differently. Unlike pasta, rice isn't consistent because it's a natural product and the first batch cooked from a new purchase of rice can be hit and miss – the rice cooker does mitigate this to an extent, but adjusting the amount of water is a sure way of getting the rice you like.



If the rice you cook is too soft, next time reduce the water you add for cooking by 3-4mm, softer rice means that there was too much water in the inner bowl during cooking. If the rice you cook is too hard, next time add 3-4mm more water, harder rice means that there was too little water in the inner bowl during cooking.



Do not use any kind of quick cook, partially cooked, parboiled rice – look at rice packets carefully to make sure the rice you are buying is suitable. This type of rice is not suited for use in a sealed unit, fuzzy logic rice cooker.

5. GUIDE TO CLAYPOT RICE

Due to the unique properties of Tsuki's handmade (clay) natural ceramic bowl, traditional style 'claypot rice' can be cooked in Tsuki. This is a traditional dish that has many versions spanning from Dominican Republic to Spain to Korea.

Making claypot rice is made very easy with this cooking function on Tsuki. Here is a recipe to get you started for the delicious one pot meal Hong Kong style claypot rice.

HONG KONG STYLE CLAYPOT RICE

Ingredients (2 servings)

2 cups long grain rice

8cm piece of cured pork belly (of char sui pork) cut into strips

1-2 links of sweet Chinese sausage

10 dried shiitake mushrooms (soak in hot water for a minimum of 30 minutes)

1 baby pak choi sliced in half

Sauce ingredients - mix together

1 tablespoon regular soy sauce

1 tablespoon seasoned soy sauce (蒸鱼豉油, zhēng yú chǐ yóu or you can substitute with kecap manis)

½ tablespoon dark soy sauce

1 tablespoon fish sauce

1/8 teaspoon sugar

1/8 teaspoon white pepper

1 spring onion (chopped in small pieces)

Directions

1. Prepare the sliced cured pork belly, thickly slice the Chinese sausage and drain the shiitake mushrooms in a sieve (reserve the soaking liquid).
2. Remove the stalks of the mushrooms (you can use these for adding to a stock or soup for extra flavour) and slice into thick pieces.
3. Wash rice and then place into inner bowl, add the mushroom soaking liquid and top up with water to the 2 line on the long grain scale.
4. Press the 'Menu' button until you get to the 'Claypot' setting. 1:15 will appear on the display, press 'Start'.
5. When Tsuki beeps (0:45 will show on the display), add the pork belly, Chinese sausage and shiitake mushrooms.
6. When the cooking cycle finishes, add the pak choi on top and close the lid. Leave for 10 minutes on keep warm.
7. Add the sauce mix to the top of the rice and mix into the rice, mixing the pork, sausage and pak choi in with the rice. Break up the crust into the rice.

6. RECIPES

Here are a couple of recipes to start you off with your new rice cooker.

For lots more recipes like flavoured rice (Mexican and coconut rice), risotto, stews, soups and more, please see our foodie blog at www.greedy panda.co.uk

RICE PORRIDGE (CONGEE)

Ingredients (4-5 servings)

1 cup of rice
75g chicken thighs, chopped and parboiled
Pinch of salt
Ginger and spring onion (scallion), shredded – to taste

Directions

1. Wash rice and place into inner bowl, add water (follow levels on the inner bowl) then place the chicken on top
2. Press the 'Menu' button and select 'Porridge' and press and hold the 'Start' button
3. When the rice cooker turns to 'Keep Warm,' add salt if you want it and garnish with ginger and spring onions

OATMEAL PORRIDGE

Ingredients (serves 1 – do not exceed quantities)

½ cup steel cut or high quality large rolled oats (we advise you put these in a sieve and shake hard 3-4 times to dislodge any sediment)
1.5 cups water (measured in the provided measuring cup)
1 cup of milk (or 1 cup of coconut milk or other non-dairy milk – whatever you prefer)
3-4 spoons (or more to your own taste) honey or brown sugar
* You may need to experiment with the amounts of oats and water, depending on whether you like thick or thin oat porridge!

Directions

1. Place oats and water in the inner cooking pan.
2. Place the inner cooking pan in the main body of the rice cooker, plug in the unit, select the 'Porridge' setting and adjust the timing to what you prefer (longer cooking time = thicker porridge; less cooking time = thinner porridge) press the 'Start' button.
3. When the rice cooker turns to Keep Warm open the lid, stir and add the remaining ingredients. Using the Timer function and soaking the oats overnight will soften the texture of the oats.
4. Add any dried or fresh fruit to the porridge instead of sugar – delicious and healthy on a cold winter's day!!



Do not use milk to cook the oats, this will result in a 'boil over' of the contents as milk reacts differently when heated. **Only use water to cook the oats.**

SUSHI ROLLS

Ingredients (4-5 servings)

2.5 cups of rice

For the sushi seasoning (vinegar mix) – 4 tbsp rice vinegar, 1 tbsp sugar, 1.5 tsp salt

Whatever topping you prefer (sashimi, prawns, pickles, natto, salmon roe, eel)

Seaweed, wasabi, soy sauce and pickled red ginger for garnish

Directions

1. Wash rice and place into inner bowl, add water (follow the water levels on the inner bowl and use the 'Short Grain' menu option)
2. When the rice cooker turns to 'Keep Warm,' place the rice in a wooden container (wiped with a clean, wet cloth) and pour the vinegar mix over the rice, mixing whilst cooling with a fan
3. Hand rolled sushi is simple and quick, it's just a case of wrapping your favourite ingredient with nori (seaweed)

RICE PUDDING

Ingredients (cup measures are for the rice measuring cup 4-6 servings)

2 cups arborio, other short-grain rice or sticky/glutinous rice

½ cup evaporated milk

½ cup coconut milk

1 cup sweetened condensed milk

1 cinnamon stick or pinch of ground cinnamon

1 lemon zest, one large piece of lemon peel

½ teaspoon nutmeg (or less if you prefer)

A sprinkle of ground cinnamon (to garnish)

Directions

1. Measure your short grain rice with the measuring cup you got with your rice cooker.
2. Rinse rice in cold water, place rice and water (to the correct line on the inner bowl) into the rice cooker, choose the 'Short Grain' rice setting.
3. Meanwhile whisk evaporated milk, coconut milk, sweetened condensed milk, cinnamon stick (or ground cinnamon), lemon zest (a large thin slice of zest, not grated) and nutmeg together.
4. When rice is cooked and the rice cooker has switched to Keep Warm, add the whisked milks into the rice, close the lid. Check about 30 minutes later and see if it is at the consistency you like.
5. Discard the cinnamon stick (if using) and the lemon zest.
6. Place into individual dishes and garnish with ground cinnamon and cream if desired.



** Vegan adaptation - this can also be made without the evaporated milk and condensed milk as a non-dairy alternative.

Use one whole tin of coconut milk and some non-dairy milk to loosen it after stage 5 if necessary.

7. COOKING WITH OTHER GRAINS/PULSES IN TSUKI

It's possible to cook other grains and pulses in Tsuki, here is a rough guide for cooking times/settings

QUINOA

If it's not pre-washed, make sure you rinse it well in a sieve with cold water. Use a 1:1 ratio of quinoa to water (up the water to 1:1.25 if you are using black quinoa) and use the long or short grain setting. Once it's finished cooking, fluff up a little and leave on Keep Warm for 5-10 minutes.

COUS COUS and GIANT COUS COUS

Use the water levels indicated on the packet and use the long or short grain setting as cous cous doesn't require that much cooking anyway.

MILLET

For each portion you want to cook, measure $\frac{1}{4}$ cup of millet into the inner bowl and add 1 cup water for each portion (so if you use $\frac{3}{4}$ cup millet add 3 cups water; for $\frac{1}{2}$ cup millet add 2 cups water and so on).

Shake a small dash of salt into the water, then close the lid. Plug in the rice cooker and select the 'Porridge' cycle. You can either cook straight away adjusting the timing for how you prefer your millet (longer cooking will have a thicker consistency; less cooking will have a thinner consistency) or you can use the Preset timer for when you will want to eat in the morning. Once cooked you can add whatever flavouring you prefer

LENTILS and BEANS

The slow cook setting is ideal for cooking lentils or beans – rinse beforehand and follow the water levels indicated on the pack. The porridge setting also works for cooking lentils and beans, if you want to cook at a lower temperature.

PEARL BARLEY

The slow cook setting is ideal for cooking pearl barley - rinse before cooking and follow the water levels indicated on the pack. Using pearl barley in a batch of soup will cook within an hour but won't overcook if left for longer.

8. CLEANING AND MAINTENANCE

Always remove any remaining pieces of food and clean immediately after use.

Do not use any kind of metal brush, scrubber or harsh chemicals/solvents to clean the dirty parts of the appliance.

Do not immerse the appliance in water. Use a damp sponge or soft cloth to clean the outer case. Do not wash the outside of the bowl or immerse the bowl in water.

Do not wash rice in the inner bowl, this can cause scratches and the inner bowl coating to deteriorate. Any damage caused by washing rice in the bowl will not be covered by our warranty

IMPORTANT - Never put the inner bowl or inner lid into a dishwasher. The chemicals and washing cycle of a dishwasher are too harsh.

Any damage caused by a dishwasher will not be covered by our warranty.

INNER LID CARE

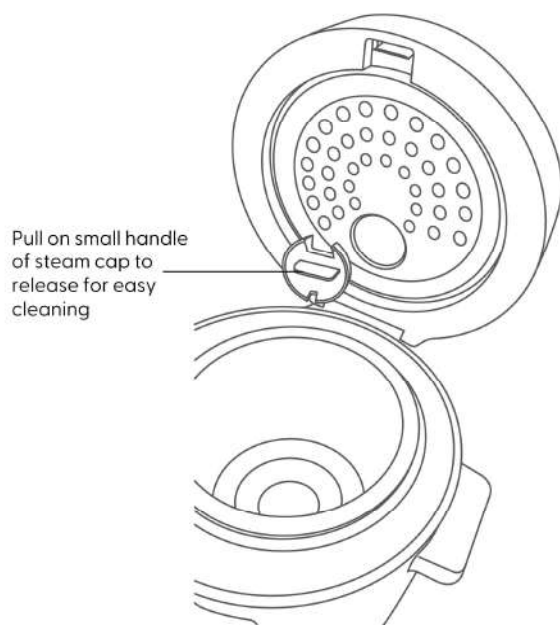

The inner lid of this appliance is not removable.

There is a small steam vent cap in the bottom centre of the lid. Pull on the small handle but be careful not to pull up or down, pull in a straight line otherwise the small handle could break.

Wash the steam vent, dry it and put back in place.

After each use, wipe the inner lid clean with a damp cloth and dry. Make sure to dry the rubber gasket properly as water can gather in here.

IMPORTANT INNER BOWL CARE

Only ever use the plastic accessories provided, you can also use wooden or silicone accessories. Never use metal to stir as this will damage the ceramic coating on the inner bowl.

Cleaning the inner bowl is easy, but if anything remains stuck to the inner bowl, pre-soak with a little washing up liquid before washing.

Do not pour vinegar into the inner bowl as this will damage the ceramic coating.

The outside (underneath) of the inner bowl will discolour and scuff due to the heat being applied to the bowl from the heating element, this is normal.

The ceramic coating on the inner bowl may change colour over time. This is completely normal and nothing to worry about.

In contrast to other rice cooker inner bowls, Tsuki's inner bowl is made from a natural material and made by hand, the coating layer of the bowl may look uneven.

Do not immerse the inner bowl into water this will affect how the inner bowl conducts the heat

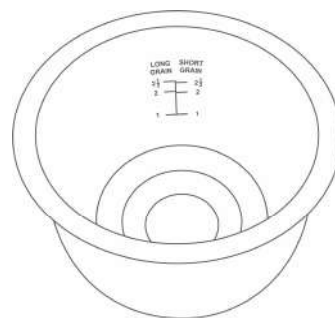

9. REPLACEMENT PARTS

If you need spare parts, please contact us via our website www.yum-asia.com or e-mail hello@yum-asia.com. Spare parts available (measuring cups are available to purchase on our website):

Part Name	Part Number
Ceramic coated inner bowl	IB-TS04
Steam cap	SC-TS04

10. TROUBLESHOOTING GUIDE

	PROBLEM	POSSIBLE CAUSE
COOKING RICE	Rice cooks too hard or too soft	<ul style="list-style-type: none"> • Make sure the appliance is on a flat surface, if it is on an uneven surface, the water level becomes inconsistent and it will affect the cooking of the rice. • The texture of rice varies depending on how it's been processed • Using the 'Preset' function can result in a softer rice texture if the rice has soaked in the water for a length of time. • Make sure the inner bowl isn't cracked • Did you loosen the rice after cooking? If not, do this to allow excess water to evaporate
	Rice is scorched/burnt	<ul style="list-style-type: none"> • Make sure nothing is stuck to the inside of the rice cooker or the bottom of the inner bowl • Rice may not have been washed enough, leaving too much starch on the rice • Make sure the inner bowl isn't cracked
	Boils over while cooking	<ul style="list-style-type: none"> • Check the 'Menu' setting you have selected and the water level you have filled to • Make sure the steam vent cap is on the appliance
	Unable to Start cooking or buttons won't respond	<ul style="list-style-type: none"> • Make sure the power cord is pushed as far into the appliance as possible
	A noise is heard during cooking or Keep Warm	<ul style="list-style-type: none"> • A clicking noise is just the microprocessor (MICOM) adjusting the cooking temperature of the appliance, it is nothing to worry about.
	Steam comes out from between the outer lid and main body	<ul style="list-style-type: none"> • Check the outer lid is fitting properly and has not deformed. Is the outer lid gasket dirty? If so, clean the outer lid gasket
KEEP WARM	Rice has a smell, is yellow or there is excessive moisture	<ul style="list-style-type: none"> • Do not keep very small amounts of rice on 'Keep Warm'. Has the 'Keep Warm' been used for more than 12 hours? • The type of rice and water may have caused the rice to look yellow. Was the spatula left in the inner bowl whilst on 'Keep Warm' • Did you loosen rice immediately after it had cooked – if not, loosen • It may be a left-over smell from a previous cooking cycle (especially if slow cooking dishes)
TIMER COOKING	Appliance Starts cooking immediately	<ul style="list-style-type: none"> • The minimum default time is 1.5hrs, anything less than this will Start the cooking cycle immediately
	Food isn't ready at the set time	<ul style="list-style-type: none"> • Cooking may not complete at the set time if the temperature in the room or the water level is too low • Was there a power cut? This may cause the unit to reset
GENERAL ERROR ON DISPLAY	'E' error on display, unit beeps and the menu functions won't respond	<ul style="list-style-type: none"> • Is the inner bowl in place in the unit? If you try and operate the unit without the bowl in place, this is a safety feature to stop use without an inner bowl • Has the rice cooker boiled over? • Sensors on the unit may have malfunctioned, please contact Yum Asia for further resolution

11. SPECIFICATIONS AND COOKING TIMES

Model name and number	Tsuki, YUM-TS04T/W
Capacity	0.45 litre (1 to 2.5 cups) rice cooker or 1.16 litre slow cooker
Rating	AC 220-240V, 50-60Hz
Electric consumption	500W
Average power consumption on 'Keep Warm'	21W
Cooking system	Direct Heating
Country of manufacture	China
Length of power cord	1m
External dimensions (approximate)	23cm (length) x 26cm (width) x 20cm (height)
Weight (approximate)	2.7kg

	FEATURE	CAPACITY	APPROXIMATE COOKING TIMES
COOKING CAPACITY (cups or litres)	White Long grain rice	1-2.5 cups/0.45l	29-39 minutes
	White Short grain rice	1-2.5 cups/0.45l	28-36 minutes
	Yumami (white) rice	1-2.5 cups/0.45l	60-70 minutes
	Brown rice	1-1.5 cups/0.27l	49-50 minutes
	Porridge (oat or rice)	½ cup/0.09l	1 hour, can be adjusted to 1:5 hours maximum
	Claypot	1-2.5 cups/0.45l	1.5 hours
	Slow Cook	1.5 litres	2 hours, can be adjusted to 6 hours maximum

12. CERTIFICATION AND WARRANTY

Included with this appliance is our comprehensive warranty (please see warranty card included). For more details of our warranty go to www.yum-asia.com/uk/warranty (UK) and www.yum-asia.com/eu/warranty (EU)

This Yum Asia rice cooker and multi-function cooker is designed for DOMESTIC USE ONLY. It's use in a commercial setting will invalidate this warranty.

If you encounter a problem with your appliance, please first look at the 'Troubleshooting' guide on page 18 of the manual to see if your problem is listed there. If you continue to have a problem, please e-mail hello@yum-asia.com with your order details, a description and photos of the problem.



Your appliance is designed and manufactured with the highest quality materials and components which can be recycled and re-used.
 This symbol means that electrical and electronic equipment, when at their end of life, should be disposed of separately from household waste. Please dispose of this appliance at your local community waste/recycling centre.



This appliance is compliant with the Restriction Of Hazardous Substances (RoHS) directive.



This appliance is certified for compliance for distribution and use in the EEA



This appliance is certified for compliance for distribution and use in the UK

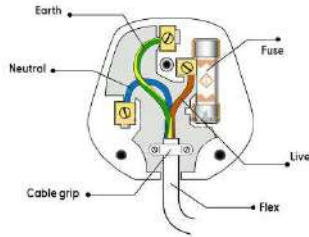

IMPORTANT! - The wires in this mains power cord are coloured as:

Green and yellow = Earth Brown or Red = Live Blue or Black = Neutral
 Connect the Earth wire (green and yellow) to the terminal in the plug which is marked with the letter E or by the earth symbol or coloured green and yellow. Connect the Neutral wire to the terminal which is marked with the letter N or coloured black. Connect the Live wire to the terminal which is marked with the letter L or coloured red. This appliance must be protected by a 13A fuse if a 13A (BS1363) plug is used.

YUM ASIA
 UK – USA – EU

www.yum-asia.com
 © Yum Asia

UK OFFICE

Yum Asia
 Horizon International Cargo Limited
 Unit 14, 5 Mills Road
 Aylesford
 Kent ME20 7NA

EU OFFICE

Yum Asia
 SCAN GLOBAL LOGISTICS BV
 Amsterdam warehouse
 Kaapstadweg 36A
 1047HG Amsterdam
 Netherlands



Hidden Under

Display And Control Panel