

Panda

by Yum Asia



Ninja
Ceramic Bowl

Advanced Fuzzy Logic
Multifunction Mini Rice Cooker

3.5 cup - 0.6 litre (1-3 people)

Model - YUM-EN06-SEA, YUM-EN06W-SEA, YUM-EN06G-SEA



Ninja

Small
FOOTPRINT

ADVANCED 
Fuzzy Logic (AI)

INDEX

1.	IMPORTANT SAFEGUARDS Please follow these instructions.....	3
2.	APPLIANCE DESCRIPTION.....	6
2.1	APPLIANCE DESIGN.....	6
2.2	CONTROL PANEL DISPLAY.....	7
3.	APPLIANCE OPERATION.....	8
3.1	BEFORE USE.....	8
3.2	NAVIGATING THE CONTROLS.....	8
3.3	HOW TO USE THE RICE COOKER FUNCTIONS.....	8
3.4	HOW TO USE THE KEEP WARM FUNCTION.....	9
3.5	HOW TO USE THE OTHER COOKING FUNCTIONS.....	9
3.6	CANCELLING PROGRAMMES.....	10
3.7	HOW TO USE THE DELAYED START (PRESET) FUNCTION.....	10
4.	TIPS TO COOKING GREAT TASTING RICE.....	11
4.1	HOW TO COOK PERFECT RICE.....	11
4.2	OUR TIPS FOR RICE COOKING AND GETTING PERFECT RESULTS.....	12
5.	HOW TO USE THE STEAM FUNCTION.....	12
6.	HOW TO BAKE CAKE.....	13
7.	RECIPES.....	13
7.1	CAKES.....	15
8.	COOKING WITH OTHER GRAINS/PULSES IN PANDA.....	16
9.	CLEANING AND MAINTENANCE.....	16
10.	REPLACEMENT PARTS.....	18
11.	TROUBLESHOOTING GUIDE.....	18
12.	SPECIFICATIONS AND COOKING TIMES.....	20
13.	CERTIFICATION AND WARRANTY.....	20

Model YUM-EN06/W/G

Panda

Thank you for choosing this Yum Asia Multi-Function Mini Rice Cooker Model YUM-EN06 which we named 'Panda'.

Here at Yum Asia our experience of working with major leading brands of rice cookers and technology has given us the knowledge required to produce this perfect cooker. This means that this product has been designed to the highest standards of quality, functionality, design and more importantly with the passion we have for cooking great rice!

We guarantee that you will be satisfied with your new appliance and this is backed up by our comprehensive warranty service.

For further details, go to www.yum-asia.com/sea/warranty or see the warranty card enclosed. Keep these operating instructions stored away with your warranty card, receipt, and, if possible, the cardboard box and packaging. The latest version of these instructions may be found for viewing or download at www.yum-asia.com

If you have any questions about this product, cooking advice or anything else then please contact us at hello@yum-asia.com and we will be happy to help.

ATTENTION!

Before using the appliance read these instructions carefully. It contains important information on your safety as well as recommendations on proper appliance use and maintenance.

Thank you once again and happy cooking!









The Yum Asia Team

1. IMPORTANT SAFEGUARDS Please follow these instructions

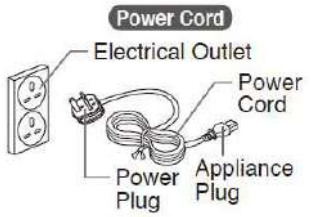

THESE WARNINGS AND CAUTIONS ARE INTENDED TO PREVENT PROPERTY DAMAGE OR PERSONAL INJURY TO YOU AND OTHERS

	<p>Do not modify this rice cooker, only a repair technician may disassemble or repair this unit.</p>		<p>Do not allow children to use the rice cooker unsupervised. Keep it out of reach of very young children. Children are at risk of burns, electric shocks or injury.</p>
	<p>Do not touch the steam vent. Doing so may cause scalding, burns. Take special care with children.</p>		<p>Do not open the lid or move the rice cooker during the cooking cycle. Doing so may cause burns – the steam is very hot.</p>
	<p>Do not plug or unplug the power cord with wet hands. Doing so may cause electric shocks or injury.</p>	<p>This rice cooker is for cooking rice and other dishes detailed in this manual. Do not use other than for the intended purposes. Always follow the operating instructions and never cook the following: Foods packed in plastic Dishes that use paper towels or other lids to cover the food. Doing so may cause the steam vent to clog.</p>	
	<p>Do not immerse the rice cooker in water or splash with water. Doing so may cause a short circuit or electric shocks.</p>		
	<p>Do not put any metal objects in the air vents. Doing so may cause electric shocks or malfunction resulting in injuries.</p>		
	<p>Insert the power plug completely and securely into the electrical socket.</p>	<p>A loosely inserted power plug may cause fire, electric shocks, short circuit, smoke or fire. Use only an electrical outlet that is rated at 15 amperes minimum. If you want to change the power cord, only use one which a similar rated cord (250v, 13A).</p> <p>If the blades of the plug are dirty, wipe them clean. Debris on the blades of the plug can cause fire.</p>	

	<p>This appliance is intended for household use only. Any use for commercial purposes will void the warranty.</p>		
	<p>Do not use if the power cord or plug is damaged or if the power plug is loosely inserted into the electrical socket. Doing so may cause electric shocks, short circuit or fire. Do not damage the power cord.</p> <div data-bbox="349 562 657 777" style="display: flex; align-items: center;">  <div style="margin-left: 20px;"> <p>Do not bend, twist, bundle or attempt to modify the power cord. Do not place the cord on or near high</p> </div> </div> <p>temperature surfaces or appliances, under heavy items or between objects. A damaged power cord can cause electric shocks or fire.</p>		<p>Unplug the power cord from the electrical socket when not in use.</p>
	<p>Do not use any other parts other than those supplied with this rice cooker.</p>		<p>Allow enough space next to walls, other furniture and under shelves for the steam to escape.</p>
	<p>Do not use this rice cooker in a place where it may come into contact with water or other heat sources.</p>		<p>Do not touch hot surfaces during, or immediately after, use. Be careful of steam when opening the lid and be careful not to touch the inner bowl while stirring the rice. Touching hot surfaces with metal parts like the inner lid, inner bowl and heating plate may cause burns.</p>
			<p>Do not place or use this rice cooker on an uneven surface or on a surface that is vulnerable to heat. Doing so may cause fire.</p> <p>Do not use this rice cooker on a slide-out table or shelf with insufficient load capacity. Doing so may damage the table of shelf, causing the rice cooker to fall, resulting in injury or burns. Any shelf or slide-out table must have a load-bearing capacity of at least 18kg.</p>



IMPORTANT!

Allow the rice cooker to cool down before cleaning. Hot parts like the inner lid, inner bowl and heating plate may cause burns.

Always unplug the rice cooker by holding the power plug, not by pulling the power cord.

Insert the end of the power cord firmly into the rice cooker, otherwise it may cause electric shocks, fire and the rice cooker may not work.

Do not cover the main body of the rice cooker, especially the steam vent while cooking.

Do not damage the inner bowl or inner lid. A deformed inner bowl or lid will cause uneven cooking results.

Make sure nothing is stuck to the heating element or the outside of the bowl. This will cause uneven cooking results.

Do not splash water on the rice cooker. This may cause the breakdown of the unit, fire or electric shock.

Do not use the rice cooker in direct sunlight. This may cause discolouration.

Do not use where the steam from this rice cooker may come into contact with other appliances. The steam may cause discolouration, malfunction, fire to other appliances.

Do not use on a surface where the air vents underneath could get blocked (like on paper, carpet, plastic)

Do not cook when the inner bowl is empty. This may cause the breakdown of the unit.

Stop using immediately if you notice ANY of the following:

The power plug or cord has become very hot.

The power cord is damaged or the electricity turns on/off when touched

The body of the rice cooker is deformed or unusually hot

Smoke is coming from the rice cooker or there is a burning smell

Any part of the rice cooker is cracked, loose or unstable.

2. APPLIANCE DESCRIPTION

Your Panda fuzzy logic mini rice cooker is a modern multi-function cooking appliance using the highest quality manufacturing and our years of experience selling rice cookers.

Saving space in your kitchen, this appliance combines quality functions of speciality rice cooking with porridge, steam, slow cook and cake baking. We designed this rice cooker with additional features that any cook will find useful. An easy-to-use Smart button control function panel with adjustable timings for different functions will make cooking so much easier and produce delicious rice or full meals.

2.1 APPLIANCE DESIGN

Meet your Panda rice cooker! It is supplied with a rice spatula, a soup ladle, a measuring cup and a steam basket.

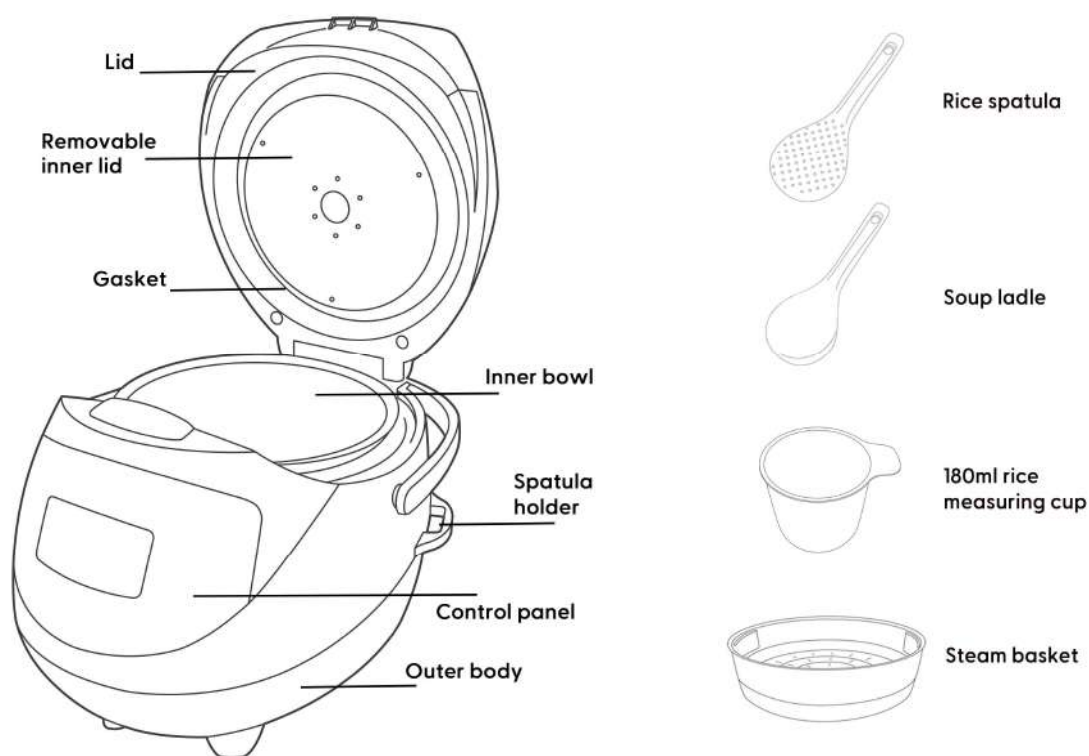

2.2 CONTROL PANEL DISPLAY

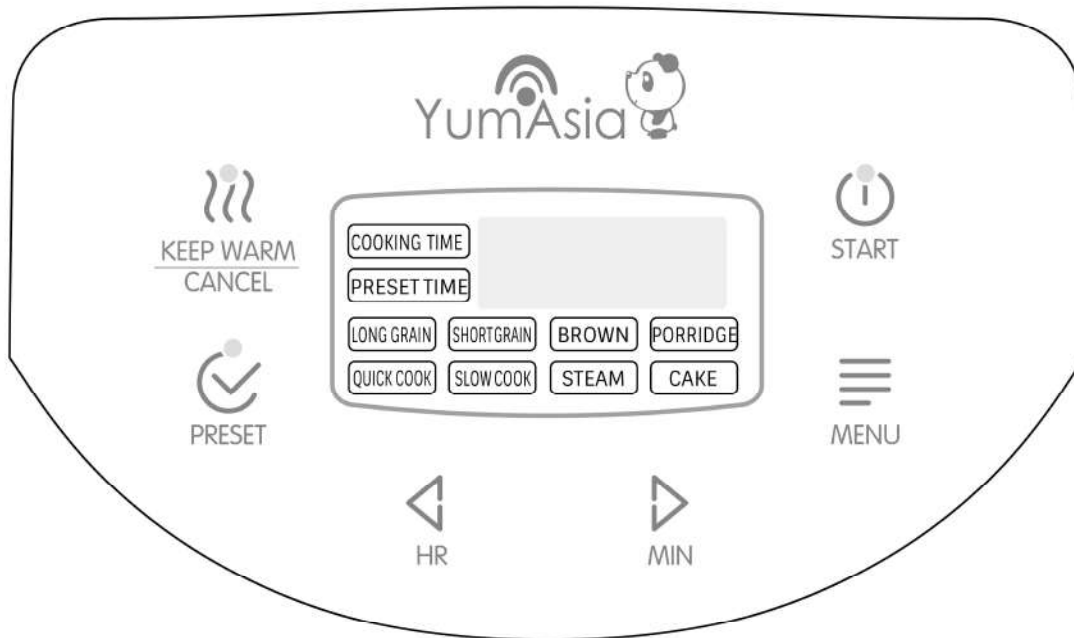

START

Press the 'START' button to activate the cooking program which you have previously selected with 'MENU' button. Once cooking has started, the 'START' button lights up and a chasing lines pattern appears on the display.

This button also doubles as an on/off button when no cooking function is selected



KEEP WARM
CANCEL

If the unit is in stand-by mode (i.e. no programme is in use) pressing the 'KEEP WARM/CANCEL' button activates KEEP WARM mode, the 'KEEP WARM/CANCEL' button lights up and a count-up clock appears on the display for your reference.

To cancel any cooking programme or the keep warm, press the 'KEEP WARM/CANCEL' button



MENU

Press this button to select 1 of 4 automatic cooking programmes or 1 of 4 rice cooking programmes, each successive press of the button moves through the menu and the selected programme flashes on the display.



PRESET

The 'PRESET' function allows you to set a timer for delayed cooking of up to 24 hours. Beware of setting this for too long in the future if there are perishable foods among the contents of the dish you are cooking. You know the timer is set as the 'PRESET' button lights up.



HR MIN

For adjusting the cooking times for non-rice cooking menu settings and the preset function. Pressing one of these buttons when a programme has been selected allows you to adjust the cooking time.

Default cooking times are listed under the specific manual sections for different programmes.

3. APPLIANCE OPERATION

3.1 BEFORE USE

1. Open the packaging, take out the appliance carefully, and remove all packaging and promotional material.
2. Take out all the accessories and the operating manual.
3. Remove any promotional stickers. Wipe the appliance case with a wet cloth.
4. Wash the bowl and inner lid in warm soapy water with a soft sponge. Dry it thoroughly.
5. Cook ½ cup of rice (for water, fill measuring cup to ½ with water) and throw it away.

3.2 NAVIGATING THE CONTROLS

The display of this unit uses Smart button controls and is easy to use with a bright 'Ice White' display. Press the button you want to use firmly, you will see that each button is slightly raised, so it's easy to move through the menu options.



When no cooking programme is selected, **Panda can be turned off** by **pressing the Start** button. To **switch Panda on**, **press the Start** button again.

3.3 HOW TO USE THE RICE COOKER FUNCTIONS

NOTE - the maximum capacity of this appliance (Do Not Exceed!)
3.5 cups (180ml = 1 cup) for WHITE rice
2.5 cups (180ml = 1 cup) for BROWN rice

Panda is designed to cook rice using 7 distinct phases to produce perfect rice every time and to carefully retain nutrients. These phases are Preheat, Absorb water, Heating, Boiling, Braising, Absorb water and then finally Keep warm (in this order). This phased cooking and adjustments in temperature are controlled using Panda's fuzzy logic processor.

OPTIONS FOR COOKING RICE:

1. **'LONG GRAIN'** setting is for cooking long grain white rice (for example, basmati, jasmine or Thai fragrant rice)
2. **'SHORT GRAIN'** setting is for any type of white short grain rice like pearl or sushi rice and Thai sticky rice.
3. **'BROWN'** setting is for cooking long or short grain brown rice
4. **'QUICK COOK'** setting (for white rice only) for when you want the rice completed a little faster.

Approximate cooking times for different types of rice

Rice Selected	'LONG GRAIN'	'SHORT GRAIN'	'BROWN'	'QUICK COOK'
Time taken	40 mins	40 mins	62 mins	22 mins



During the rice cooking cycles, a chasing lines pattern comes on the display to indicate Panda is cooking, a **countdown** will appear in the **last 10 minutes**.

There are markings on the inside of the inner bowl to indicate the water levels for white long grain rice, white short grain rice, brown rice and (rice) porridge.

Cooking **STICKY** or **GLUTINOUS** rice

Sticky or glutinous rice is different to normal short grain rice. If you are cooking sticky/glutinous rice you need to follow the water guidance below and use the short grain setting.

3.3.1 COOKING RICE IN PANDA

1. **Measure** the rice with the measuring cup provided. Make sure the rice is level to the top of the cup – this is a full cup (180ml) measurement.
2. **Clean the rice** (if needed) as directed in '4.1 HOW TO COOK PERFECT RICE'. Place the inner bowl into the appliance, **put the rice into the inner bowl** and **fill to the water line** that corresponds to the amount of rice you are cooking.
3. Close the lid and **select** the rice setting you want to cook with.
4. Press '**START**' and the cooking cycle will begin. A chasing lines pattern comes on the display to indicate Panda is cooking, a countdown will appear in the last 10 minutes.



Also see the 'Speedy Start Guide' on the back of the warranty card for a step-by-step guide on how to cook rice and 'Tips to Cooking Great Tasting Rice' on page 12 for more detailed cooking information and advice.



If you want to cook $\frac{1}{2}$ cup of rice, there isn't a mark on the inner bowl for this. Use the measuring cup to add the water – $\frac{1}{2}$ a measuring cup of water for white rice and $\frac{3}{4}$ cup of water for brown rice.

3.4 HOW TO USE THE KEEP WARM FUNCTION

Once a cooking cycle has finished, the appliance will automatically switch to 'KEEP WARM'.

You can activate 'KEEP WARM' when the appliance is on stand-by (i.e. when no menu functions have been selected) by pressing the 'KEEP WARM' button. The button will then light up and a count-up clock will appear on the display for your reference. The 'Keep Warm' function can be used for 24 hours but you may find that the rice is dry after 15 hours (as rice has to be kept at a safe temperature to eat). You can extend this by periodically adding a little water to the rice and stirring through.

To cancel 'KEEP WARM', press the 'KEEP WARM' button again (it doubles as the 'CANCEL' button). The appliance will then switch to stand-by mode.

3.5 HOW TO USE THE OTHER COOKING FUNCTIONS

3.5.1 PORRIDGE

This menu setting can be used for Asian rice porridge or oatmeal porridge. For recipes, see page 14.

The default cooking time for the 'PORRIDGE' setting is 1.5 hours. You can adjust this up to 4 hours using the 'Hr' button or adjust in 10 minute intervals using the 'Min' button once you have selected the 'PORRIDGE' setting and it is blinking on the display.

Once the cooking cycle is complete, the appliance will make a sound and will automatically switch to 'KEEP WARM'.

3.5.2 STEAM

Using the provided steaming basket, you can steam different types of food. You can cook rice and steam food at the same time - use the corresponding rice function for the rice you are cooking.

The default cooking time for the 'STEAM' setting is 10 minutes. You can adjust this up to 1 hour in 10 minute intervals using the 'Hr' or 'Min' buttons once you have selected the 'STEAM' setting and it is blinking on the display. There will be a countdown on the display when the water has been heated to the appropriate temperature; you can use cold or hot water. Using hot water rather than cold water helps speed up the heating process for the steam setting and fill water to the 1.5 mark on the inner bowl

See Section 5, page 13 for a guide to steaming.

3.5.3 SLOW COOK

For cooking stews and other dishes like curries, dhal, or other pulses/grains select the 'SLOW COOK' setting.

The default cooking time for the 'SLOW COOK' setting is 2 hours. You can adjust this up to 8 hours using the 'Hr' button or in 10 minute intervals using the 'Min' button once you have selected the 'SLOW COOK' setting and it is blinking on the display. When the 'SLOW COOK' cycle starts, the appliance heats the contents of the inner bowl to a high temperature (you will hear bubbling from the liquid), it then switches to a lower temperature for the slow cooking. This is the same as the 'auto' setting on a conventional slow cooker. Once the cooking cycle is complete, the appliance will make a sound and will automatically switch to 'KEEP WARM'.



Panda is a very efficient, sealed unit fuzzy logic rice cooker, the slow cook setting will cook food faster as there is no heat loss. A normal slow cooker recipe with a cook time of 7-8 hours will take 3-4 hours to cook in Panda. This is to give a more efficient slow cook.

3.5.4 CAKE

For cooking delicious cakes, select the 'CAKE' setting. The cake setting on your Panda makes delicious and moist cakes. Please see section 6 on page 13 for more detailed instructions for cake baking. The default cooking time for the 'CAKE' setting is 50 mins. This time can be adjusted down to 30 mins and up to 60 mins in 10 mins intervals using the 'Hr' or 'Min' buttons once you have selected the 'CAKE' setting and it is blinking on the display.

Once the cooking cycle is complete, the appliance will make a sound and will automatically switch to 'KEEP WARM'.

3.6 CANCELLING PROGRAMMES

To cancel a programme, you have selected or if you want to stop a programme part way through the cooking cycle, you just need to press the 'KEEP WARM/CANCEL' button. The appliance will then switch to standby mode.

3.7 HOW TO USE THE DELAYED START (PRESET) FUNCTION

The 'PRESET' function is a useful timer/delayed start feature; this allows you to set the appliance to have your rice or food ready at a specific time. It can be used for all settings apart from the 'QUICK' rice cook.

To set the timer:

1. Press the 'MENU' button to select a cooking programme (for non-rice cooking programmes you can programme the length of cooking time at this point).
2. Then press the 'PRESET' button which will then light up.
3. By pressing the 'Hr' and 'Min' touch buttons you can select the hours in advance when the rice/dish should be ready.
4. Press the 'START' button, the cooker will display the hours/minutes in advance you selected, start to count down and the cooking cycle will complete at the time you specified.

If the preset/timer is set to below the minimum stated in the below table, the cooking cycle will start immediately. This is because the default cooking time for each cooking cycle has to be taken into account along with additional assessment time for the fuzzy logic to know what it is cooking.

Suggested timings for the 'PRESET' function

Function	RICE	PORRIDGE	STEAM	SLOW COOK
Preset time	70m - 24hrs	70m - 24hrs	1hr - 24hrs	130m - 24hrs

Note – be aware that perishable foods should not be left for long periods of time when you have set the 'PRESET' function as they may spoil.



The start time of the preset/timer is not exact, it will come on slightly earlier as Panda has to assess what exactly is in the inner bowl (rice/oats/water) and volume so it can calculate the cooking time effectively. It deals with this by turning the unit on early so it can 'assess' the contents

4. TIPS TO COOKING GREAT TASTING RICE

4.1 HOW TO COOK PERFECT RICE

Measure the rice accurately! Use the 180ml measuring cup provided as other cup sizes may be different measurements. Make sure you level the rice off at the top of the cup.

Rinse the rice! Place the rice into a sieve or a bowl and pour fresh, cold water on top. Stir the rice loosely by hand and drain the water. Do this 2-3 times until the water you are rinsing with runs clear.

For example:
when cooking 3 cups
of WHITE rice

Fill to water level 3

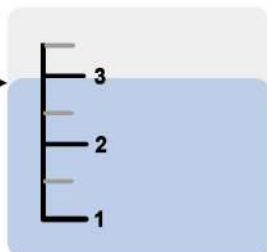

Be accurate with the water! The amount of water in the inner bowl prior to cooking greatly affects the texture of the cooked rice. The more water you use, the softer the rice will be when cooked. We recommend after washing the rice, you place in the inner bowl, then top up with water to the corresponding line on the inner bowl – fill to the underside of the line, this will give you perfect rice. If you prefer it softer, fill to the top of the line; if you prefer it harder, fill to 2-3mm below the line.

Stir and loosen! once the appliance has switched to 'KEEP WARM', if possible, stir and loosen the rice straight away with the provided spatula. This helps release excessive moisture and results in nice, perfect fluffy rice.

4.2 OUR TIPS FOR RICE COOKING AND GETTING PERFECT RESULTS



Try and choose bags of rice with as few broken grains as possible, as broken grains make rice very soggy and sticky.



It is important to remember that every batch of rice is different - even the rice you regularly buy can sometimes change for the worse quality - each batch of rice absorbs water differently depending on how well it's been processed. The end result can also depend on the age of the rice you use. Newer rice needs less water than older rice but, of course, there is no way of knowing whether the rice you have bought is an older or newer picked grain.



If the rice you cook is too sticky, it's worthwhile trying a batch without rinsing, as some varieties of rice don't need rinsing as they have been processed differently. Unlike pasta, rice isn't consistent because it's a natural product and the first batch cooked from a new purchase of rice can be hit and miss - the rice cooker does mitigate this to an extent, but adjusting the amount of water is a sure way of getting the rice you like.



If the rice you cook is too soft, next time reduce the water you add for cooking by 3-4mm, softer rice means that there was too much water in the inner bowl during cooking. If the rice you cook is too hard, next time add 3-4mm more water, harder rice means that there was too little water in the inner bowl during cooking.



Do not use any kind of quick cook, partially cooked, parboiled rice - look at rice packets carefully to make sure the rice you are buying is suitable. This type of rice is not suited for use in a sealed unit, fuzzy logic rice cooker.

5. HOW TO USE THE STEAM FUNCTION

You can use this appliance as a stand alone steamer (fill with water to the 1.5-2 line on the bowl) or you can cook rice at the same time as steaming food. If steaming whilst cooking rice, you would use the rice function for the type of rice you are cooking and add the steaming basket to the inner bowl above the rice. Here is a guide for estimated cooking different types of food on the 'STEAM' function:

INGREDIENTS	AMOUNT	COOKING TIME	TIPS FOR STEAMING
Carrot	75g	20 mins	Cut into bite-size pieces
Broccoli	75g	15 mins	Cut into bite-size pieces
Spinach	40g	15 mins	Cut into bite-size pieces
Pumpkin	95g	20 mins	Cut into bite-size pieces
Potato	165g	40 mins	Cut into bite-size pieces
Sweet Potato	110g	35 mins	Cut into bite-size pieces
Corn	75g	30 mins	Cut into bite-size pieces
Chicken	150g	30 mins	Make cuts on side touching steam basket
Fish (white fish and salmon)	75g/cut into fillets	25 mins	Slice to less than 2cm and wrap in foil
Prawn	75g/7 pcs	20 mins	Steam without removing shells
Scallop	75g	20 mins	Prawns - Steam without removing shells. Scallops - Remove from shell
Refrigerated Meat Dumpling	75g	15 mins	Leave space between foods
Frozen Meat Dumpling	75g	20 mins	Leave space between foods



IMPORTANT - Do not steam food over 3.5cm thick.

If you would like to combine cooking rice with steaming, it is recommended that **1 cup of rice is the maximum capacity**. Any more than this the steaming basket will push into the lid.



If cooking rice and steaming at the same time, you can open the lid (very carefully, minding the steam that is released from the unit) to add the steaming basket part way through the cooking cycle so the vegetables are not over-cooked.

6. HOW TO BAKE CAKE

1. Grease the inner bowl lightly and evenly with butter or oil.
2. Prepare the cake batter. Note – do not use too much baking powder or baking soda as it may cause the cake to rise too high. The maximum weight for all ingredients is 300g, do not exceed this.
3. Place the inner bowl on a hard, flat surface and place the cake mixture into the inner bowl. Shake a little and tap the underside of the bowl gently with the palm of your hand (do this several times) to release any air bubbles in the cake mixture.
4. Place the inner bowl into the appliance and close the lid. Press the 'MENU' button until the 'CAKE' setting blinks on the control panel. You can then choose the length of cooking time – default is 50 minutes but this can be adjusted down to 30 minutes and up to 60 minutes in 10 minute intervals. Press the 'START' button to start the cooking cycle.
5. Once the cooking cycle is finished, the appliance will switch to 'KEEP WARM', check the cake with a wooden toothpick or skewer to see if it is cooked. If not, you can cancel the 'KEEP WARM' by pressing the 'KEEP WARM/CANCEL' button and select the 'CAKE' setting as detailed in step 4 to cook for longer.

See section 7.1, page 16 for cake recipes to cook.

7. RECIPES

Here are a couple of recipes to start you off with your new rice cooker.

For lots more recipes like flavoured rice (Mexican and coconut rice), risotto, stews, soups and more, please see our foodie blog at www.greedy-panda.com or purchase The Greedy Panda Cookbook.

RICE PORRIDGE (CONGEE)

Ingredients (2-3 servings)

1/2 cup of rice
35g chicken thighs, chopped and parboiled
Pinch of salt
Ginger and spring onion (scallion), shredded – to taste

Directions

1. Wash rice and place into inner bowl, add water (to level 3 on the bowl) then place the chicken on top.
2. Press the 'MENU' button and select 'PORRIDGE' and press the 'START' button.
3. When the rice cooker turns to 'Keep Warm', add salt if you want it and garnish with ginger and spring onions.

OATMEAL PORRIDGE

Ingredients (serves 2)

½ cup steel cut or high quality rolled oats (we advise you put these in a sieve and shake hard 3-4 times to dislodge any sediment)

1½ cups water (measured in the provided measuring cup)

1 cup of milk (or 1 cup of coconut milk or other non-dairy milk – whatever you prefer)

3-4 spoons (or more to your own taste) honey or brown sugar

* You may need to experiment with the amounts of oats and water, depending on whether you like thick or thin oat porridge!

Directions

1. Place oats and water in the inner cooking pan.
2. Place the inner cooking pan in the main body of the rice cooker, plug in the unit, select the 'PORRIDGE' setting and adjust the timing to what you prefer (longer cooking time = thicker porridge; less cooking time = thinner porridge) press the 'START' button to start.
3. When the rice cooker turns to keep warm open the lid, stir and add the remaining ingredients. Using the Timer function and soaking the oats overnight will soften the texture of the oats.
4. Add any dried or fresh fruit to the porridge instead of sugar – delicious and healthy on a cold winter's day!!



Do not use milk to cook the oats, this will result in a 'boil over' of the contents as milk reacts differently when heated. **Only use water to cook the oats.**

SUSHI ROLLS

Ingredients (4-5 servings)

3 cups of rice

For the sushi seasoning (vinegar mix) – 4 tbsp rice vinegar, 1 tbsp sugar, 1.5 tsp salt

Whatever topping you prefer (sashimi, prawns, pickles, natto, salmon roe, eel)

Seaweed, wasabi, soy sauce and pickled red ginger for garnish

Directions

1. Wash rice and place into inner bowl, add water (follow the water level guidance on page 9 and use the 'SHORT GRAIN' menu option)
2. When the rice cooker turns to 'Keep Warm', place the rice in a wooden container (wiped with a clean, wet cloth) and pour the vinegar mix over the rice, mixing whilst cooling with a fan
3. Hand rolled sushi is simple and quick, it's just a case of wrapping your favourite ingredient with nori (seaweed)

RICE PUDDING

Ingredients (cup measures are for the rice measuring cup)

1 cup arborio, other short-grain rice or sticky/glutinous rice

1 cup cold water (i.e. fill to 4-5mm below the 1 mark on the inner bowl)

¼ cup evaporated milk

¼ cup coconut milk

½ cup sweetened condensed milk

1 cinnamon stick or pinch of ground cinnamon

1 lemon zest, one large piece of lemon peel

½ teaspoon nutmeg (or less if you prefer)

A sprinkle of ground cinnamon (to garnish)

Directions

1. Measure your short grain rice with the measuring cup you got with your rice cooker.
2. Rinse rice in cold water, place rice and water into the rice cooker, choose the 'SHORT GRAIN' rice setting and start the cooking cycle. Cook until it clicks automatically to keep warm.
3. Meanwhile whisk evaporated milk, coconut milk, sweetened condensed milk, cinnamon stick (or ground cinnamon), lemon zest (a large thin slice of zest, not grated) and nutmeg together.
4. When rice has been cooked and the rice cooker has switched to warm, disconnect the cord from outlet, stir once and let the cooked rice cool for 15 minutes.
5. Then add the whisked milks into the rice, close lid and set the cooker to the 'KEEP WARM' setting. Check about 30 minutes later and see if it is at the consistency you like.
6. Discard the cinnamon stick (if using) and the lemon zest.
7. Place into individual dishes and garnish with ground cinnamon and cream if desired.



** Vegan adaptation - this can also be made without the evaporated milk and condensed milk as a non-dairy alternative.

Use one whole tin of coconut milk and some non-dairy milk to loosen it after stage 5 if necessary.

7.1 CAKES

For cakes, you can make things easier by using a ready-made cake mix and adding your favourite ingredients, they still turn out perfectly. If you want to make your own cake batter, be sure to follow the guidance on maximum ingredients. See our foodie blog at www.greedy-panda.com for more cake recipes that you can scale down for cooking in Panda.

CHOCOLATE BROWNIE

Ingredients

2 ½ tablespoons of sunflower or coconut oil
100g dark (at least 70% cocoa) chocolate
85g of self-raising flour (or plain flour with 1 level teaspoon of baking powder)
1 ½ tablespoons of cocoa powder
90g golden caster sugar
115ml soya milk (or any other milk)
a pinch of salt, less than 1/8 tsp

Directions

1. Grease the inner bowl with a little sunflower oil
2. Break 75g of the chocolate and melt – either in a heatproof bowl over a pan of water or by a quick blast in the microwave. Leave to cool a little
3. Sieve flour and cocoa powder into a large bowl and add the sugar and a pinch of salt. Stir in the oil, soya milk and melted chocolate until combined – it really doesn't take much to combine the ingredients.
4. Roughly chop the remaining 25g of chocolate and stir into the mixture.
5. Pour into Panda's inner bowl, smoothing the top a little with a spoon. Pat the bottom of the inner bowl on a flat palm, just to settle the mixture.
6. Bake for 30 minutes. Check after 30 minutes with a it should come out with some mixture stuck to it (in the middle). The top will still be quite soft, don't worry about this, the brownie keeps on cooking while it cools, you don't want to overcook it!
7. Leave to cool in the inner bowl and once cooled completely, tip out and cut into pieces



As you can see from the ingredients, this is a vegan/dairy free recipe, so the maximum weight restrictions on cake doesn't apply to this recipe as there isn't any eggs to cook. It's a delicious brownie and you'd never guess it was dairy-free!

8. COOKING WITH OTHER GRAINS/PULSES IN PANDA

It's possible to cook other grains and pulses in Panda, you would need to experiment with adjusting water levels and selecting the correct cooking cycle. Here is a rough guide that may help cooking other grains and pulses in Panda.

QUINOA

If it's not pre-washed, make sure you rinse it well in a sieve with cold water. Use a 1:1 ratio of quinoa to water (up the water to 1:1.25 if you are using black quinoa) and use the quick cook setting. Once it's finished cooking, fluff up a little and leave on keep warm for 5-10 minutes.

COUS COUS and GIANT COUS COUS

Use the water levels indicated on the packet and use the quick cook setting as cous cous doesn't require that much cooking anyway.

MILLET

For each portion you want to cook, measure $\frac{1}{4}$ cup of millet into the inner bowl and add 1 cup water for each portion (so if you use 1 cup of millet, add 4 cups water; using the measuring cup to measure the water)

Shake a small dash of salt into the water, then close the lid. Plug in the rice cooker and select the 'Porridge' cycle. You can either cook straight away adjusting the timing for how you prefer your millet (longer cooking will have a thicker consistency; less cooking will have a thinner consistency) or you can use the preset timer for when you will want to eat in the morning. Once cooked you can add whatever flavouring you prefer

LENTILS and BEANS

The slow cook setting is ideal for cooking lentils or beans – rinse beforehand and follow the water levels indicated on the pack. The porridge setting also works for cooking lentils and beans if you want to cook at a lower temperature.

PEARL BARLEY

The slow cook setting is ideal for cooking pearl barley - rinse before cooking and follow the water levels indicated on the pack. Using pearl barley in a batch of soup will cook within an hour but won't overcook if left for longer.

9. CLEANING AND MAINTENANCE

Always remove any remaining pieces of food and clean immediately after use.

Do not use any kind of metal brush, scrubber or harsh chemicals/solvents to clean the dirty parts of the appliance.

Do not immerse the appliance in water. Use a damp sponge or soft cloth to clean the outer case.

Do not wash rice in the inner bowl as this may scratch and damage the coating on the inner bowl.

IMPORTANT - Never put the inner bowl or inner lid into a dishwasher. The chemicals and washing cycle of a dishwasher are too harsh.

Any damage to parts caused by a dishwasher will not be covered by our warranty.

INNER LID CARE

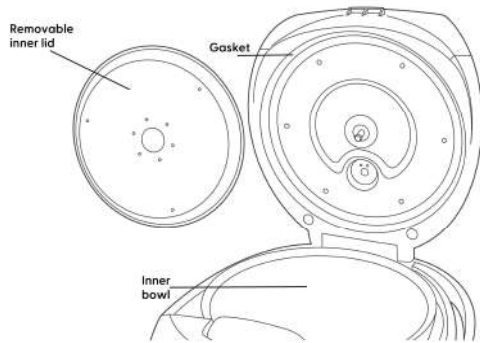

The inner lid of this appliance is removable.

Press on one side of the lid and then pull on the opposite edge, the lid will then come off.

Wash the removable lid after each cooking cycle with a sponge in soapy water.

IMPORTANT INNER BOWL CARE

Only ever use the plastic accessories provided, you can also use wooden or silicone accessories. Never use metal to stir as this will damage the ceramic coating on the inner bowl.

Cleaning the inner bowl is easy, but if anything remains stuck to the inner bowl, pre-soak with a little washing up liquid before washing.

Do not pour vinegar into the inner bowl as this will damage the ceramic coating.

Do not wash rice in the inner bowl, it can damage the ceramic coating.

The outside (underneath) of the inner bowl will discolour and scuff due to the heat being applied to the bowl from the heating element, this is normal. The ceramic coating on the inner bowl may change colour over time. This is completely normal and nothing to worry about.

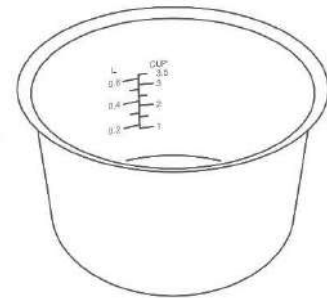

STEAM CAP CARE

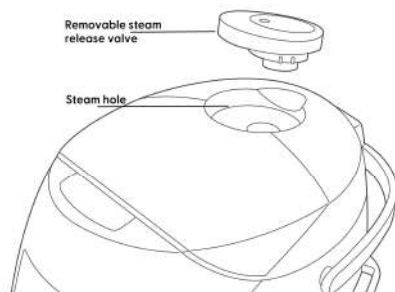

The steam cap on top of the lid is removable – pull upwards to remove.

Wash this on a regular basis.

The removable steam cap can also be fully dissembled to ensure full cleaning – ensure this is put together properly before use.

CONDENSATION COLLECTOR CARE

The condensation collector on the back of the appliance can be removed. Pull on the small handle but be careful not to pull up or down, pull in a straight line otherwise the small handle could break.

Remove and empty the condensation collector. Wash, dry and install it back into place.

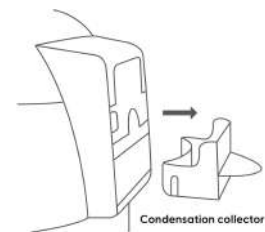

10. REPLACEMENT PARTS

If you need spare parts, please contact us via our website www.yum-asia.com or e-mail hello@yum-asia.com. Spare parts available for Panda YUM-EN06 (180ml measuring cups are available to purchase on our website):

Part Name	Part Number
Ceramic coated inner bowl	IB-EN06
Detachable inner lid	ILSS-EN06
Steaming basket	SB-EN06

11. TROUBLESHOOTING GUIDE

PROBLEM		POSSIBLE CAUSE
COOKING RICE	Rice cooks too hard or too soft	<ul style="list-style-type: none"> • Make sure the appliance is on a flat surface, if it is on an uneven surface, the water level becomes inconsistent and it will affect the cooking of the rice. • The texture of rice varies depending on how it's been processed (see section 4.3 for more information) • Using the 'PRESET' function can result in a softer rice texture if the rice has soaked in the water for a length of time. • Using the 'QUICK COOK' setting may result in harder rice • Make sure the inner bowl isn't deformed. • Did you loosen the rice after cooking? If not, do this to allow excess water to evaporate.
	Rice is scorched/burnt	<ul style="list-style-type: none"> • Make sure nothing is stuck to the heating element or bottom of the inner bowl. • Rice may not have been washed enough, leaving too much starch on the rice. • Make sure the inner bowl isn't deformed.
	Boils over while cooking	<ul style="list-style-type: none"> • Check the 'MENU' setting you have selected and the water level you have filled to. • Make sure the steam vent cap is on the appliance.
	Unable to start cooking or buttons won't respond	<ul style="list-style-type: none"> • Make sure the power cord is pushed as far into the appliance as possible.
	A noise is heard during cooking or keep warm	<ul style="list-style-type: none"> • A clicking noise is just the microprocessor (MICOM) adjusting the cooking temperature of the appliance, it is nothing to worry about. • A 'sparking' noise may occur if the inner bowl has any kind of moisture on the bottom of it as the heating element warms. Make sure the inner bowl is completely dry.
	Steam comes out from between the outer lid and main body	<ul style="list-style-type: none"> • Check the outer lid is fitting properly and has not deformed. • Is the outer lid gasket dirty? If so, clean the outer lid gasket.
	Cake is not cooked or doesn't rise	<ul style="list-style-type: none"> • The cooking time may have been too short. • Beat any egg whites until foamy, otherwise there may not be sufficient rise to the cake. • Do not beat egg whites too much – if they separate, they are beaten too much and will cause the cake to collapse. • Measure the ingredients accurately – inaccuracy in measuring can cause insufficient baking/rising.

PROBLEM		POSSIBLE CAUSE
CAKE BAKING		<ul style="list-style-type: none"> Over-mixing the batter when adding the flour may cause insufficient baking or rising. Adding too many additional ingredients can cause the cake to bake unevenly – follow the amount listed in recipes Bake the cake immediately after preparing the batter - allowing the batter to sit for an extended period may deflate the batter and cause the cake to collapse.
	Cake rises too much	<ul style="list-style-type: none"> Did you add baking powder or baking soda? Do not use too much baking powder or baking soda as it may cause the cake to rise too high.
	Cake is difficult to release from the inner bowl	<ul style="list-style-type: none"> Make sure you grease the inner bowl well. Leave the cake to cool completely.
	The cake breaks easily	<ul style="list-style-type: none"> Freshly baked cake can break easily. Make sure you leave the cake to cool completely before turning out or handling
	The cake is scorched/burnt	<ul style="list-style-type: none"> Make sure the inner bowl isn't deformed. The cooking time may have been too long, make sure you follow the recommended cooking times.
	NOTE – do not place other cake pans or wax paper into the appliance or inner bowl. Doing so may cause a malfunction or the inner bowl to deform.	
STEAMING	Food does not steam	<ul style="list-style-type: none"> Is there sufficient water for steaming? Make sure there is water to at least the two cup mark on the inner bowl. Is there too much food in the steaming basket? – reduce the amount of food or increase the cooking time. The food may be in too large pieces, reduce the size of food pieces or increase the cooking time.
	Steamed food is too hard	<ul style="list-style-type: none"> Vegetables – steaming time was too short. Make sure there is enough water and continue to steam. Fish and meat – steaming time was too long. Reduce the cooking time.
	Steamed food is cold	<ul style="list-style-type: none"> Has too much time elapsed from when the cooking cycle ended? Try not to leave on 'KEEP WARM', remove immediately from the appliance and eat.
KEEP WARM	Rice has a smell, is yellow or there is excessive moisture	<ul style="list-style-type: none"> Do not keep very small amounts of rice on 'KEEP WARM' Has the 'KEEP WARM' been used for more than 24 hours? The type of rice and water may have caused the rice to look yellow. Was the spatula left in the inner bowl whilst on 'KEEP WARM'. Did you loosen rice immediately after it had cooked – if not, loosen. It may be a left-over smell from a previous cooking cycle (especially if slow cooking dishes).
TIMER COOKING	Appliance starts cooking immediately	<ul style="list-style-type: none"> The minimum default time is 70 minutes (plus the cooking cycle time), anything less than this will start the cooking cycle immediately.
	Food isn't ready at the set time	<ul style="list-style-type: none"> Cooking may not complete at the set time if the temperature in the room or the water level is too low. Was there a power cut? This will cause the unit to reset.

12. SPECIFICATIONS AND COOKING TIMES

Model name and number	Panda, YUM-ENO6-SEA/YUM-ENO6W-SEA/YUM-ENO6G-SEA
Capacity	0.6 litre (1 to 3.5 cups) rice cooker or 1.75 litre slow cooker
Rating	AC 220-240V, 50/60Hz
Electric consumption	350W
Average power consumption on 'KEEP WARM'	15W
Cooking system	Direct heating
Country of manufacture	China
Length of power cord	0.9m
External dimensions (approximate)	30cm (length) x 22.5cm (width) x 21cm (height)
Weight (approximate)	2.36kg

	FEATURE	CAPACITY	APPROXIMATE COOKING TIMES
COOKING CAPACITY (cups or litres)	Quick cook rice	1-3.5 cups/0.6l	26 minutes
	White Long grain rice	1-3.5 cups/0.6l	35 minutes
	White Short grain rice	1-3.5 cups/0.6l	39 minutes
	Brown rice	1-2.5 cups/0.45l	62 minutes (1 hr, 2 minutes)
	Porridge (rice)	½ cup/0.09l	1 hour, can be adjusted to 4 hours maximum
	Porridge (oat)	½ cup/0.09l	10 minutes, can be adjusted up to 1 hour maximum in 10 mins intervals
	Steam	Water to 1 cup rice mark	2 hours, can be adjusted to 8 hours maximum
	Slow Cook	0.6 litres	50 mins, can be adjusted down to 30 mins and up to 1 hour maximum in 10 mins intervals
	Cake	300g of all ingredients	

13. CERTIFICATION AND WARRANTY

Included with this appliance is our comprehensive warranty (please see warranty card included). For more details of our warranty go to www.yum-asia.com/sea/warranty (UK)

This Panda rice cooker and multi-function cooker is designed for DOMESTIC USE ONLY. It's use in a commercial setting will invalidate this warranty.

If you encounter a problem with your appliance, please first look at the 'Troubleshooting' guide on page 19 of the manual to see if your problem is listed there.

If you continue to have a problem, please e-mail hello@yum-asia.com with your order details, a description and photos of the problem.

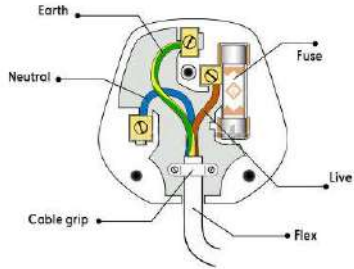

IMPORTANT! - The wires in this mains power cord are coloured as:

Green and yellow = Earth Brown or Red = Live Blue or Black = Neutral

Connect the Earth wire (green and yellow) to the terminal in the plug which is

marked with the letter E or by the earth symbol or coloured green and

yellow. Connect the Neutral wire to the terminal which is marked with the

letter N or coloured black. Connect the Live wire to the terminal which is

marked with the letter L or coloured red. This appliance must be protected

by a 13A fuse if a 13A (BS1363) plug is used.

YUM ASIA

UK – USA – EU - SEA

www.yum-asia.com

© Yum Asia

UK OFFICE

Yum Asia
Scan Global Limited
Unit 14, 5 Mills Road
Aylesford
Kent ME20 7NA

HONG KONG OFFICE

Yum Asia
Sea-Air Logistics (HK) Ltd,
G/F., "J" Warehouse,
No. 1-7 Sai Tso Wan Road,
Tsing Yi Island, Hong Kong



Ninja

Ceramic Bowl